

Barry Smith, Editor

Parts and Moments  
Studies in Logic and  
Formal Ontology

Authors:

Wolfgang Künne  
Kevin Mulligan  
Gilbert T. Null  
Peter M. Simons  
Roger A. Simons  
Barry Smith  
Dallas Willard

Philosophia Verlag · München · Wien

# Contents

Preface 13

Barry Smith and Kevin Mulligan

## **Pieces of a Theory**

§ 1	From Aristotle to Brentano	15
§ 2	Stumpf's Theory of Psychological Parts	25
§ 3	Husserl's 3rd Logical Investigation: The Formal Ontology of the Part-Whole Relation	35
§ 4	The Theory of Material <i>A priori</i> Structures; Phenomenology and Formal Ontology	45
§ 5	The Influence of the <i>Logical Investigations</i> on Logical Grammar and Linguistics. Husserl and Leśniewski	55
§ 6	Further Developments: Köhler, Lewin, Rausch	65
	Notes	92

Peter M. Simons

## **Three Essays in Formal Ontology**

Prefatory Note 111

### **I. The Formalisation of Husserl's Theory of Wholes and Parts**

§ 1	Introduction	113
§ 2	Problems of Formalisation	117
§ 3	Husserl's Basic Concepts: Whole and Foundation	121
§ 4	Dependence	133
§ 5	Husserl's Six Theorems	142
§ 6	Applications	147
§ 7	Relations and Foundation	151
	Notes	155

### **II. Number and Manifolds**

§ 1	Introduction: The Philosophy of Number	160
-----	--	-----

§ 2	Frege's Criticisms of Manifold Theories	161
§ 3	Plural Terms and their Designata: Manifolds	164
§ 4	Against the Group Theory of Number	168
§ 5	Counting and the Mereological Properties of Aggregates	177
§ 6	One and Zero	185
§ 7	There are no Second-Order Manifolds	187
	Notes	195
<b>III. Plural Reference and Set Theory</b>		199
§ 1	Classes as Many and as One: Historical Remarks	200
§ 2	Linguistic Phenomenology of Plural Reference	206
§ 3	Problems of Formalisation	215
§ 4	Axiomatisation of Manifold Theory	220
§ 5	Some Comparisons	236
§ 6	Sets as Representatives of Classes	244
§ 7	Concluding Remark	249
	Notes	250
	Bibliography	256

Eugenie Ginsberg

### **On the Concepts of Existential Dependence and Independence**

	Editorial Note by P. M. Simons	261
§ 1	Analysis of Stumpf's Definitions	266
§ 2	Analysis of Höfler's Definitions	267
§ 3	Analysis of Twardowski's Definitions	269
§ 4	Husserl's Definitions	271
§ 5	Analysis of Husserl's Definition of Dependence in Application to Objects	272
§ 6	Analysis of Husserl's Definitions of Dependence in Application to Parts	274
§ 7	Analysis of Another Husserlian Definition of Dependence	275
§ 8	Analysis of Husserlian Definitions of Independence	276
§ 9	An Attempt to Define Dependence and Independence	277
§ 10	Possible Classifications of Dependence and Independence	279
§ 11	Elements of the Relation of Dependence	281
§ 12	Conclusion	282

Notes	283
Bibliography	286

Barry Smith

**Introduction to Adolf Reinach**

**On the Theory of the Negative Judgment**

§ 1 Kant and Hume on the Material <i>A priori</i>	289
§ 2 The Philosophy of <i>Sachverhalte</i>	293
§ 3 The Theory of Social Acts	297
§ 4 On the Nexus of Representation	303
Notes	308

Adolf Reinach

**On the Theory of the Negative Judgment**

I. Investigations of Judgment in General	
§ 1 The Ambiguity of the Term 'Judgment'	315
§ 2 The Sphere of Conviction and the Sphere of Assertion	317
§ 3 Acts of Presentation and Acts of Meaning	321
§ 4 The Independence of Meaning and Intuition	325
§ 5 Judgment and Presentation (Critique of Brentano)	328
II. States of Affairs	
§ 6 Positive and Negative Position-Takings	332
§ 7 The Objectual Correlates of Judgments: Judgments and Relations	334
§ 8 States of Affairs as Objectual Correlates of Assertion and Belief	336
§ 9 Further Characteristics of States of Affairs	338
§ 10 The Apprehension of States of Affairs: Judgment vs. Apprehension	341
§ 11 States of Affairs and Relations	345
§ 12 On Impersonalia	346
§ 13 Negative Conviction	351
III. Negative States of Affairs and the Sphere of Assertion	
§ 14 The Character of the Assertive Sphere: Simple and Polemical Negative Judgments	355
§ 15 Cognitive Functions: 'And', 'Hence' and 'Not'	358

§ 16	The Moment of Assertion	361
§ 17	The Pure Logic of Emphasis	363
§ 18	<i>Sachverhaltselemente</i> (The Elements of States of Affairs)	366

#### IV. The Locus of Negation

§ 19	Subjective and Objective Aspects of Negative Judgments	369
§ 20	Negation of the Predicate and of the Copula: The Doctrine of Infinite Judgments	370
§ 21	Concluding Remarks	371
	Notes	372
	Bibliography	376

Dallas Willard

#### **Wholes, Parts and the Objectivity of Knowledge**

§ 1	Ontology Presupposed in Epistemology	379
§ 2	Three Aspects of the Objectivity of Knowledge	380
§ 3	Husserl's First Problem: The Objectivity of Formal Methods in Arithmetic	382
§ 4	The Problem Generalised	383
§ 5	Transcendence Becomes the Main Issue	387
§ 6	The Beginnings of a Solution	389
§ 7	Wholes, Parts and Properties in the Objectivity of Knowledge	396
	Notes	398
	Bibliography	400

Wolfgang Künne

<b>Criteria of Abstractness. The Ontologies of Husserl, Frege and Strawson against the Background of Classical Metaphysics</b>		401
§ 1	Non-Perceptibility (First Platonic Demarcation-Proposal)	402
§ 2	Unchangeability (Second Platonic Demarcation-Proposal)	406
§ 3	Non-Reality (Frege's Criterion and the Category of Individual Moments)	413

§ 4 Individual Moments and Properties: Husserl's Aristotelianism	419
§ 5 Sense-Determinate Singular Terms (Strawson's Demarcation-Proposal)	424
Notes	432
Bibliography	435

Gilbert T. Null and Roger A. Simons

**Manifolds, Concepts and Moment-Abstracta**

§ 1 Introduction	439
§ 2 Isomorphism Types	446
§ 3 Manifolds	448
§ 4 Further Aspects of Manifold Theory	455
§ 5 Interpreting Whole-Part Notions in Manifold Theory	464
§ 6 Ontology and Epistemological Interpretations of Manifold Theory	473
Bibliography	479

Barry Smith

**Annotated Bibliography of Writings on Part-Whole Relations since Brentano**

481

**Index**

553

## Preface

The present volume had its origin in seminars on phenomenology organised by Wolfe Mays in Manchester between 1973 and 1976. A constantly recurring theme of these seminars, propounded initially by Kevin Mulligan, was the importance to phenomenology, and to philosophy in general, of the theory of part and whole sketched by Husserl in the 3rd Logical Investigation. The Manchester seminars led in 1977 to the formation of the Seminar for Austro-German Philosophy. Our ideas on whole and part were much clarified, in particular, by a meeting of the Seminar held in Sheffield in May 1978 on *Whole-Part Theory and the History of Logic*, at which papers were read by Peter Simons, Prof. C. Lejewski, Ivor Grattan-Guinness, Prof. F. G. Asenjo and Wolfgang Degen. We are grateful to Degen, in particular, for invaluable inspiration, and to Prof. R. M. Chisholm, Hans Burkhardt, Ignacio Angelelli and Herman Philipse for their criticism and encouragement.

The Seminar for Austro-German Philosophy owes its existence to the kind support of Prof. P. H. Nidditch of the Department of Philosophy of the University of Sheffield. I should like to express my thanks also to the Faculty of Arts of that University for the grant of a research fellowship from 1976 to 1979, during which period my own contributions to this volume were written.

B. S.

Manchester, February 1981.

## Pieces of a Theory

### § 1 From Aristotle to Brentano

The whole, that which is compounded out of something, is one, not like a heap, but like a syllable. Now the syllable is not its elements; *ba* is not the same as *b* and *a*, nor is flesh the same as fire and earth (for when these are separated the wholes, i. e. the flesh and the syllable, no longer exist, but the elements of the syllable exist, and so do fire and earth); the syllable, then, is something – not only its elements (the vowel and the consonant) but also something else, and the flesh is not only fire and earth, or the hot and the cold, but also something else.

*Metaphysics*, 1041<sup>b</sup> 12, trans. Ross, slightly amended.

**1.1** There is an Averroist saying to the effect that all sciences are perfect insofar as Aristotle treated of them. This applies not least to the formal ontological theory of wholes and parts developed by logicians, psychologists, phenomenologists and others in the last hundred years, and it is the contrast Aristotle has in mind in the passage above, between a heap and a whole or unity in the strict sense, which will be our principal concern in the pages to follow. We shall find that the opposition is by no means a simple one; that even the notion of heap, of a merely additive or summative whole, comprehends a number of quite different notions, and that the specification of the various kinds of unified whole and of the relations between them is by no means easy.

Consider, for example, the relations of part and whole encountered in the discipline of chemistry. It will be readily accepted that sub-atomic particles (*Teilchen*, in German) are in some sense constituents of atoms,



which are in turn constituents of the molecules which constitute the various things and stuffs making up the furniture of the material world. Similarly, in the field of linguistics, it will be acknowledged that individual phonemes are in some sense constituents of spoken words and phrases, that these are in turn constituents of sentences in conversations, narratives, arguments, and so on. The question of the nature of physical and chemical bonds played an important role in the work of philosophers from the 17th to the 19th centuries. Contemporary philosophers, in contrast, have tended to focus their attention on linguistic bonds, on the question how words and phrases are joined together to make a sentence.<sup>1</sup> It is however interesting to note that the answer to this question proffered by both Wittgenstein and Frege involves appeal to a theory of entities conceived as standing in need of completion (or *saturation*) in ways which call to mind the valency-rules of atomic theory.

In the present paper we wish to consider the possibility of a purely general theory of part-whole relations. It will be objected that the expectation of producing a formal ontological theory of such relations is a spurious one. For even if it is admitted that scientists (chemists, linguists, literary theorists, . . .) do in fact investigate such relational structures, still, the kinds of relations treated by each such discipline will surely be materially different, in drastic and unforeseeable ways, from those treated by every other discipline. Thus it would seem that we could hope for very little from a merely formal analysis of superficial similarities between individual cases, selected more or less at random.

Certainly much of the literature on wholes and parts – the writings of those scholastics, for example, who attempted to systematise Aristotle's remarks in this area, or the works of 19th century holistic biologists and social theorists – has failed to achieve more than a flaccid, analogical character. One is reminded of Ryle's criticism of Plato's discussion of the 'Greatest kinds' in the *Sophist* as consisting of little more than

puddings of verbal and other abstract nouns, together with opaque metaphors like 'participate', 'merge', 'blend', and 'pervade', with nothing to indicate whether we are to translate these culinary metaphors (1) in terms of 'ingredient' and 'compound' or (2) in terms of 'if' and 'therefore', that is, whether they stand for (1) relations between what can be named or (2) relations between what can be said (1960, p. 69 f).<sup>2</sup>

It could be objected further that many apparent ingredient/component/constituency relations in the object-realms of particular scientific

disciplines are in themselves nothing of the kind. In the case of the relation between atoms and molecules, for example, it might be held that the first term of the relation exists only as a theoretical construct within the framework of some physico-chemical theory. Similarly (and indeed *a fortiori*) sub-atomic particles are not *parts* of atoms, except in some highly generalised sense of 'part' whose credentials might seem dubious.

It is hoped that these and similar objections may be put to rest in the remainder of this work. Briefly, we hope to show that the case for introducing precisely such a generalised sense of the term 'part' was rigorously made by a group of philosophers working in Austria and Germany in the later 19th and early 20th centuries. They argued that the term should be recognised as comprehending not merely *extensive parts* – pieces, fragments, phases, portions, constituents – but also non-extensive *aspects, features* or *moments*. And they presented a system of *a priori* formal laws governing the relation of part to whole as thereby determined, the implications of which have still fully to be appreciated.

**1.2** The thinkers who made the most important contributions to this theory centred around Franz Brentano, and from him they inherited a system of philosophical and psychological insights rooted in Aristotelian and scholastic ideas. Hence it will be useful, before moving on to give an account of the theory, if we provide a brief survey of the relevant treatments of part-whole relations in this tradition.

There are a number of different senses in which one thing can be said to be 'in' another. Aristotle himself (*Physics* IV 3 210–24 a 14) distinguished eight such *modes of being in*. They are formulated by Peter of Spain as follows:

According to the first mode of being in, something is said to be in something, as an integral part is in its whole, e. g. a finger is in a hand, a wall is in a house.

According to the second mode, an integral whole is in its parts, e. g. a house is in its wall, roof and foundations.

According to the third mode, a species is in a genus, e. g. man is in animal.

According to the fourth mode, a genus is in a species, e. g. the animal is in the man.

According to the fifth mode, a form is in a matter. [*But this fifth mode was subdivided by Boethius into two modes,*] because there are both (1) substantial forms, e. g. the soul is the substantial form to man, and on the other hand also (2) accidental forms, e. g. the white[ness] of [a] man. Now the former is properly said to be in, as the form is in the matter, e. g. the soul in the body; the latter is said

to be in, as the accident is in the subject, e. g. the whiteness in a wall, colour in a body.

According to the sixth mode, something is in a prime cause, e. g. a reign in a regent.

According to the seventh mode, something is in an end or goal, e. g. virtue is in happiness.

According to the eighth mode, something is in a container, and generally what is placed is in a place (*Tractatus* III 2, trans. W. Degen).

Not all of these modes correspond strictly to part-whole relations in the sense propounded here, though in any fully adequate treatment of such relations it would be necessary to give some account of all of them, and of the associated issues in Aristotelian ontology (above all the theories of species and genus, matter and form).<sup>3</sup> The importance for our present purposes of Aristotle's first mode, the relation of an integral part to its whole, will become clear only later. Let it suffice here to point out that the combinatorial approach to logic, brought to successive degrees of perfection by Leibniz and Boole and later by Husserl, Leśniewski and Ajdukiewicz (see § 5 below), stems from insights of scholastic grammarians concerning the nature of integral wholes in language and the fitting together of sentences and their parts.<sup>4</sup>

Of much more immediate importance is Aristotle's fifth mode – or the relation of an individual accident to the substance in which it inheres. To fix our ideas we shall present one specific example of such inherence in some detail. Imagine a sheet of glass, *s*, which is uniformly red in colour. '*s* is red' is true, according to the theory of individual accidents, in virtue of the possession by *s* of a certain individual redness, *r*, the relation of inherence between *r* and *s* being understood as a specific type of relation of part to whole. As was stressed already by Aristotle (*Cat* I a 24–25) *r* is not a part of *s* in any of the familiar senses of 'part' (as 'piece', 'component', 'phase', etc.). The thesis that *r* is part of *s* involves an appeal to precisely that generalised sense of 'part' referred to above.

The term 'accident' is correlative with the Aristotelian 'substance'. The latter designates both mental substances (souls) and material substances: spatio-temporally extended, unified wholes which endure, are self-subsistent, and can admit contrary properties (can be, alternately, red and green, in virtue of the inherence of contrary accidents). Thus a material substance is an entity such as a sheet of glass, a human being, the head of a human being, a living cell, a molecule, perhaps also – to depart even further from Aristotle's original range of examples – a batalli-

on or division in an army, a university, a nation state, a planetary system.

Each substance is structured internally in some specific way (has what, in classical terms, would be called an essence or nature). The structures characteristic of liquid or solid consignments of inorganic matter are clearly radically distinct from, say, the structures of orbital systems, which differ in turn from the structures of, say, living organisms. All substances however are, according to their specific natures, able to acquire and lose accidents without detriment to their continued existence. Just as a human being may suffer from a headache, so an army platoon may suffer from low morale. A human being may acquire, and later lose, a knowledge of some local dialect; an army platoon may acquire, and later lose, a knowledge of some local terrain.

An accident (of a material substance) is e. g. a redness, a fall, a blush, a whistle, a salute, a specific waving of a flag; the specific taste of this piece of cheese at present on my tongue; the specific shape existing in this particular chair for the interval of time that I am presently sitting upon it; a splitting of an amoeba; a specific, concretely existing acquired knowledge, habit or skill; a specific, concretely existing disease or packet of diseases. These are all cases of accidents inhering in what might be called substances of lower order (non-institutional, non-collective substances). Examples of accidents inhering in higher order substances would be a symphony performance (inhering in a complex whole consisting of an orchestra together with a certain consignment of air-molecules and perhaps other associated objects); a state of being at war (inhering in a country); the light of Venice; the pace of Manhattan; a depression over the Atlantic.

A number of distinctions can be made amongst accidents, along various axes. They are first of all to varying degrees *measurable*. A university examination, for example, may be conceived as a device for measuring an individual knowledge of Greek. Those accidents which form one-dimensional manifolds (Gilman, 1892) may be subject either to a cardinal metric, when they exhibit what, in the tradition, were called extensive magnitudes, or to an ordinal metric (e. g. on an order of preferences), when they exhibit intensive magnitudes. We postpone further discussion of these issues to a future paper.

A distinction can be drawn, secondly, between relatively simple and relatively complex accidents. A battle, for example, consists of a number of relatively simple constituents (individual missile-movements, falls, deaths, whistles, etc.) interwoven together in complex ways; a mili-

tary procession consists similarly of a number of salutes, marchings, bangs, flyings of flags, etc. Some accidents (reddenings, falls, salutes) manifest positional and/or qualitative changes, are what we can term *dynamic accidents*. A redness, a shape, a being seated, in contrast, are all *static accidents*. A static accident is sometimes called a (concrete or individual) *property, state or condition*; a dynamic accident is sometimes called a *process or event*.<sup>5</sup>

Accidents may be further classified into relational and nonrelational. Substances are structured in specific ways, not only internally (in virtue of their essence or nature and of the accidents inhering in them and the internal relations among these accidents), but also externally: i. e. there are external relations (of causality, for example) between one substance and another. These external relations, too, insofar as they inhere in concrete individual substances for specific intervals of time, are individual accidents, but accidents inhering in more than one substance simultaneously. Examples of dynamic relational accidents are: a kiss, a hit, a throw; of static accidents: a specific relation of ownership or of being married, a specific magnetic or gravitational attraction or contractual tie existing within a given interval of time between two bodies. (Here the laws of physics and the laws of contract are seen to relate to entities which are, ontologically speaking, of the same form.) Relational accidents clearly raise difficult problems for the part-whole account of inherence presented above.

1.3 Historically the theory of individual accidents can be recognised as forming one important root of Leibniz's monadology – which rests on the denial of the existence of relational accidents (a denial which had been accepted as orthodoxy by the majority of scholastic philosophers up to Leibniz's day).<sup>6</sup> The theory of substance and accident formed a constantly recurring element in the ontological theories developed by subsequent generations of German philosophers outside the immediate orbit of Kant and Hegel (one thinks particularly of Trendelenburg, Beneke, Drobisch and Julius Bergmann). It can be recognised also in the semantics underlying Bolzano's *Wissenschaftslehre* where the form of the elementary Bolzanian *Satz an sich* is that of 's has r', in the sense in which Socrates has, say, a specific individual whiteness, intelligence, or headache.<sup>7</sup>

What distinguishes Bolzano from his predecessors, however, is that his treatment of the substance-accident relation forms part of a more

general treatment of relations of part and whole. Thus §§ 80 and 81 of the *Wissenschaftslehre*, on 'Ideas of Attributes and Relations' and 'Ideas of Matter and Form', are followed by a considerable discussion (§§ 82–87) of the ideas of *class* (and in particular the idea of a *class of individually listed objects*), of *set* (as a class where the manner of connection between elements is not specified), of *sum* (as a set the parts of whose parts are themselves parts of the whole), of *sequence*, *unity*, *manifold*, *totality*, and *finite and infinite quantity*.<sup>8</sup>

This account of different types of whole influenced Twardowski, and through him had an impact also on the Polish school of logic.<sup>9</sup> The style and content of Bolzano's account suggests that there was an influence also upon Husserl, whose *Logical Investigations* will play a prominent role in the discussions to follow.<sup>10</sup>

A second connecting link between classical substance-accident theory and 20th century philosophy is Brentano's work in logic and ontology, especially as collected in the *Kategorienlehre* (1933). The influence of classical metaphysics makes itself felt in the work of Brentano's students in the fields of logic and theoretical psychology, and it is in these works that almost all of the more recent interest in and investigation of the relations of part and whole had its mediate or immediate origin.<sup>11</sup>

A recurrent theme of scholastic metaphysics was the idea that the network of concepts and theses of a scientific discipline should approximate to the ideal of being a representationally adequate mirror of the universe. This idea finds its clearest expression in Leibniz's project of a *lingua characteristica*, but it can be recognised also in Bolzano's and Husserl's accounts of logic,<sup>12</sup> and even in the theory of integral wholes, of the *sich zueinander Verhalten* of simple objects in states of affairs and of terms in propositions, sketched by Wittgenstein in the *Tractatus*. There is, in each case, an appeal to a parallelism between the way in which words, ideas or concepts are conceived as being integral to the sentence, thought or scientific theory in the nexus of which they acquire their meaning, and the way in which corresponding objects and attributes are linked together in the realm of reference. In the *Tractatus*, in particular, an analogy is suggested between the interweaving of syntactic units and the manner in which machine or bodily parts are integral to the machine or body for which they have been tooled.<sup>13</sup>

Ontological ideas of this kind were however kept alive in German universities also by another route. To an extent as yet insufficiently appre-

ciated, the study of *Jura*, and particularly of the Roman law, served to carry forward into the 19th and early 20th centuries many crucial elements of scholastic realism, including the ontology of substance and accident. The German civil law codes were framed, quite explicitly, as standing in a relation of projection to an independently existing legal order, the individual sentences of the code mirroring corresponding legal complexes in the world of human behaviour.<sup>14</sup>

Just as a sentence, if it is to be a sentence, must as a matter of *a priori* necessity contain a verb, so there are *a priori* relationships of necessitation in the world of human behaviour, determining that, for example, a mental process of premeditation is integral to an act of murder. This is true not only in the sense that the former is seamlessly reticulated with the residue of the latter (and with events, such as the death of the victim, ensuing upon it), but also in the sense that it is indispensable to it: the existence of the act (*qua* act of murder) is dependent, as a matter of necessity, upon the existence of the process of premeditation.

It is not only *a priori* relationships of *necessitation* that can be distinguished amongst actual and possible elements of legal states of affairs however. We can distinguish also relations of *exclusion* (an act of theft, for example, excludes of necessity the obtaining of a prior relation of ownership between the thief and his booty; an act of kindness excludes, of necessity, a moment of dishonest intent); of *compatibility* (an act of contracting for gain to do  $\Phi$  is of necessity compatible with a prior intention to do  $\Phi$ ); of *indifference* (that *a* has been murdered is of necessity indifferent to the fact that he would in any case have died of cancer at the moment of his death); of *overlapping* (of, say, burglary, and trespass); and perhaps also relationships of a kind whereby one element establishes an *a priori tendency* toward the realisation of another element (an act of promising, for example, brings about a tendency toward the realisation of its content).<sup>15</sup>

The goal of providing a completely adequate catalogue of the components of legally relevant states of affairs, of their essential possibilities of combination, and of the types of *Rechtsverhältnisse* thereby constituted, has been held in common by many of the classic works of German legal theory.<sup>16</sup> For our present purposes it is Jhering's *Geist des römischen Rechts*<sup>17</sup> which is of greatest relevance. Jhering propounds in this work – in complete conformity with the scholastic idea of language as a mirror of the world – what he calls an ‘alphabet’ of possible elements of *Rechtsverhältnisse*. These elements are to be conceived as being reticulated

with entities which are not intrinsically legal (e. g. movements, and other basic actions) in complex ways, corresponding to our intuitions of the juridical world as a conceptually though not materially isolable stratum of reality. A juridical *lingua characteristic*a would make possible the direct depiction of these elements as standing in combination with each other and with extra-legal entities in such a way as to constitute integral wholes of varying types.

The most important task for any theory of integral wholes is that of providing an account of how the relevant elements are fitted together (the problem associated in the British idealist tradition with the concept of internal relation, and in the writings of Frege with the concept of saturatedness). In his treatment of this issue Jhering comes surprisingly close to the solution which was, as we shall see, developed within the Brentano school as part of a general formal ontological theory of part-whole relations. He distinguishes two sorts of component parts of legally relevant integral wholes, which he designates as elements of *local* and of *abstract applicability* respectively:

The former can be designated as self-subsistent or concrete legal substances [*Rechtskörper*], for as concrete entities they can occur in our experience without any additional supplement. Examples would be a bill of sale, a [*deed specifying a*] right of way, a will. The abstract constituents of the alphabet, in contrast, never come into our experience of themselves alone, just as little as does a property [*Eigenschaft*], but always in and of specific independent items. Examples are provided by error, invalidity, delay. An error as such, i. e. independently of any concrete *Rechtsverhältnis*, a delay as such, i. e. without any relation to an actually existing obligation, is a practical absurdity; both can occur only as bound up with self-subsistent substances. The abstract elements have an incomparably wider applicability, since they are not bound up with a specific type of relationship; error, for example, can occur in relation to a contract, a custom, a payment, a legacy, and so on. The self-subsistent elements, in contrast, relate always to quite specific types of relationships.<sup>18</sup>

The *elements* of this alphabet come together, in the world, to make legal complexes, sequences of states of affairs within the orbit of the law (as when, say, an *error* in a *contract* causes *delay* in the *execution* of some *commission*, which gives rise in turn to some specific *action* in the civil courts). Interrelationships of this kind between elements are then mirrored, in the court, by a parallel intermeshing of linguistic proxies of these same elements in the utterances of the lawyers. The legal drama in which the lawyers are engaged thereby constitutes a *picture* of the underlying substantive issue.<sup>19</sup>



1.4 That strand in the history of the theory of wholes and parts which has been most adequately treated in the literature is the theory of extensive wholes developed initially by Boole, Peirce, Schröder and their followers and further refined by Leśniewski and his school and by American logicians such as Leonard and Goodman. This work grew out of attempts by 18th century logicians and mathematicians to subject to algebraic treatment the relations amongst concepts or concept-extensions (species-genus relations) and of work on the general theory of magnitudes by, for example, the Grassmanns, Riemann and Helmholtz. Work on the algebra of logic evolved in tandem with Cantor's and Dedekind's early investigations in the theory of sets, as well as with work by Frege and Russell on concepts, concept-extensions, functions and relations.<sup>20</sup>

Unfortunately it is the latter, set-theoretical experiments which have formed the almost exclusive concern of modern philosophical logic. This entrenched position of set theory has been established partly as a result of the fact that the early growth of set/class/*Wertverlauf* theory was associated with the development of many of the most crucial advances in modern mathematical logic. It reflects also the fact that set theory is considerably more interesting from the point of view of the mathematician than the theory of extensive wholes which was, in Schröder's day, its principal competitor. Set theory has indeed subsequently come to be associated with purely mathematical advances, for example in topology.

This mathematical superiority of set theory unfortunately gave rise to the tacit assumption in the minds of philosophers that set theory is also *ontologically* superior (is possessed of greater descriptive adequacy). And this assumption was reinforced by the fact that the language of sets does indeed possess greater expressive power, even in extra-mathematical contexts, than does the language of extensive wholes. Thus it is impossible, in Schröderian, to express the distinction between *inclusion* of, say, the totality of Stagirites in the totality of Greeks, and *membership* of, say, Socrates, in the same totality, a distinction which is very economically expressed in the language of sets by the distinction between ' $\subseteq$ ' and ' $\in$ '.<sup>21</sup> Nor is it possible to capture in Schröderian the distinction between arbitrary aggregates (say the totality of left hands of soldiers in the German army in 1900) and unified wholes in the proper sense (e. g. the German army itself); this distinction can be expressed in set-theoretical terms, though only by appeal to assumptions which are *prima facie* counterintuitive (e. g. that soldiers are sets of their bodily parts).

What is certainly not the case, however, in contradiction to the tacit assumption of modern philosophical logic, is that *all* ontologically important distinctions can be captured – whether naturally or unnaturally – within the set-theoretical framework: the language of sets is *not* an adequate basis for a *lingua characteristic* in the sense demanded of a realistic, descriptively adequate, formal ontology. The claim advanced here<sup>22</sup> is that it is possible to develop an ontologically more adequate formal language, including as one fundamental component a theory of (extensive and non-extensive) part-whole relations, the underlying logic of which would have a degree of mathematical interest and sophistication at least comparable to those parts of orthodox set theory which are today employed by analytic philosophers, e. g. in work in the semantics of natural languages.

We shall have occasion in the sequel to return to this critique of the descriptive or representational adequacy of formal-ontological theories founded on a set-theoretical basis. Note that early philosophical proponents of set theory such as Russell at the time of the *Principles of Mathematics* were still, in almost all cases, concerned to develop realistic (descriptively adequate) formal ontological theories: the  $\in$ - and  $\subseteq$ -relations were held to correspond to distinct relations amongst entities existing independently of the theory. Only subsequently, particularly with the gradual recognition of an apparently irremovable arbitrariness in the proposed resolutions of the Russell paradox, did there occur a retreat to an essentially pragmatic conception of the formal logical machinery of sets, as a device for *simulating* important (or sometimes merely readily simulable) ontological relations in the world.<sup>23</sup> Philosophical proponents of a theory of wholes and parts, in contrast, even of the comparatively weak theory of extensive wholes, have retained the classical idea of formal ontology as a representationally adequate mirror of the world.

## § 2 Stumpf's Theory of Psychological Parts

2.1 The most common objections to the project of a general theory of part-whole relations rest on an illegitimate restriction to some one sense of the term 'part' – usually the extensive sense in which, e. g., one surface or mass is said to be part of a second, more inclusive surface or mass. It is then pointed out that the resultant theory is too weak to capture, for ex-

ample, the distinction between the sense in which Styria is part of Austria and the sense in which the land-area of Austria to the east of Vienna is part of Austria; or the sense in which 'th' or 'tf' are parts of the word 'thoughtful' and that in which 'thought' is a part of this word. Our claim is that a general theory of part and whole can indeed capture such distinctions. To this end however – as already intimated – it is necessary to recognise the extreme generality of the term 'part', a generality within the compass of which the requisite distinctions will be capable of being made.

To be more specific, we shall take the term to comprehend not only what we shall call *pieces*, i. e. detachable or separable parts (in a sense of these terms to be made clear below), but also (non-detachable or inseparable) *moments*. The notion of moment, of an existentially dependent entity (an entity which, as a matter of necessity, cannot exist except as a constituent part of some more inclusive whole) is an outgrowth of the Aristotelian *accident* discussed above. It can be distinguished in various forms in the works of many philosophers, even of those who on no occasion concerned themselves explicitly with the classical theory of substance and accident. In almost all cases, however, talk of recognising moments of a thing has been regarded as pertaining not to any structural features on the side of the thing itself, but only to features of our cognitive access to it.

The notion occurs, in particular, in the psychological writings of the British empiricists, especially in their treatments of the (epistemological) problem of abstraction.<sup>24</sup> Consider, for example, the following passage from Berkeley:

They who assert that figure, motion, and the rest of the primary or original qualities do exist without the mind in unthinking substances, do at the same time acknowledge that colours sounds, heat, cold, and suchlike secondary qualities, do not – which they tell us are sensations existing in the mind alone, that depend on and are occasioned by the different size, texture, and motion of the minute particles of matter. This they take for an undoubted truth, which they can demonstrate beyond all exception. Now if it be certain that those original qualities are inseparably united with the other sensible qualities, and not, even in thought, capable of being abstracted from them, it plainly follows that they exist only in the mind. But I desire any one to reflect and try whether he can, by any abstraction of thought, conceive the extension and motion of a body without all other sensible qualities. For my own part, I see evidently that it is not in my power to frame an idea of a body extended and moving, but I must withal give it some colour or other sensible quality which is acknowledged to exist only in the mind. In short, extension, figure, and motion, abstracted from all other qualities, are in-

conceivable. Where therefore the other sensible qualities are, there must these be also, to wit, in the mind and nowhere else. (*Treatise*, § 10).

It occurs also in various treatments of the problem of abstraction by continental thinkers influenced by the British psychological tradition (for instance Lotze, Lipps and Külpe). At the centre of all such treatments is a view of the concrete/abstract opposition resting on the idea that concrete entities are in some sense thinkable or presentable *in isolation*, abstract entities, in contrast, thinkable or presentable only as bound up with or in association with other entities.

It was under the combined influence of such psychological views and of the scholastic ideas preserved in classical German legal theory and in the works of philosophers such as Trendelenburg, Herbart, Beneke, Drobisch, Lotze and above all Brentano,<sup>25</sup> that there issued the beginnings of a systematic clarification of the notions abstract/concrete, separable/inseparable, etc. This crystallised in 1873 in a work whose significance for the subsequent investigation of the part-whole relation can hardly be underestimated. The work, entitled *On the Psychological Origin of the Presentation of Space*, was by Carl Stumpf, a student of Brentano and Lotze who became one of the pioneers of the discipline of experimental psychology in Germany, making fundamental contributions particularly to the psychology of sound.<sup>26</sup> Stumpf's monograph, which grew out of an unfinished history of the concept of substance, consists of a thorough historical survey and systematic criticism of previous treatments of the problem of abstraction in German and British psychological writings on the theory of visual perception (particularly on the perception of space and of spatial relationships), culminating in Stumpf's own proposed resolution of the problem. This appears in § 5 of the work, significantly entitled "The Theory of Psychological Parts". Here Stumpf considers the nature of the relation, in our presentations, between *space* and what he calls *quality* (i. e. the qualitative data of visual perception, specifically of colour). That is, he considers "*wie sich Raum und Qualität in der Vorstellung zueinander verhalten*" (Stumpf, 1873, p. 107). To answer this question, he argues, it is necessary to recognise that mental contents fall into two classes, which he calls *self-subsistent* and *partial contents* (*selbständige Inhalte und Teilinhalte*) respectively:

Independent contents are present there, where the elements of a complex of presentations could also in virtue of their nature be presented separately; partial contents where this is not the case (p. 109).

Thus for example

one cannot present to oneself a colour hue without some brightness or other, or a motion without some velocity or other . . . and it is evident to anyone who makes the attempt that it is impossible that we could either present to ourselves extension without colour or colour without extension (loc. cit.).<sup>27</sup>

The intensity of a tone is not something indifferent to its quality: the intensity cannot be held as it is while the quality varies at will, or is allowed to vanish. The two are “in their nature inseparable, they in some manner compose a total content of which they are merely partial contents” (p. 113).

Thus Stumpf’s answer to the question how space and quality *sich zueinander verhalten* is that they are mutually correlated partial contents, i. e. that they are such that according to their nature they cannot exist in presentations in separation from each other: “some space or other is given immediately with and in every presentation of quality” (p. 115). Moments of colour and extension, or the constituent moments of hue, brightness and saturation in a colour-datum,<sup>28</sup> or the constituent moments of pitch, timbre and loudness in a musical sound, are not self-subsistent atoms which somehow become (or as a matter of fact already are) glued or bonded together by association,<sup>29</sup> but entities of a quite new type, perhaps not hitherto investigated for their own sake.

This view is not without problems however. For the impossibility of separate presentation, insofar as this can be determined by a given subject or group of subjects, does not of itself suffice to demarcate an objective character of ‘partiality’ or non-self-subsistence of contents. Whilst, as Stumpf himself recognised, if we succeed in presenting to ourselves two contents in separation, then these are indeed self-subsistent contents, “nothing is decided by a lack of success in this regard” (p. 110). A pair of apparently partial contents may in fact be independent contents bound together by deeply rooted associations which could be overcome – if at all – only by protracted mental exercises of a kind not specifiable in advance.

This problem is not a trivial one since it was, after all, the impossibility of separate presentation that was used by Stumpf to introduce the notion of partial content into his theory.

One solution may be suggested by the recognition that

however consistently we might present to ourselves, say, Schiller in association with Goethe, or Beethoven in association with a sheet of music, still it never occurs to us to *predicate* the one of the other (p. 114).

That is, we should acknowledge partiality of contents only where we should find it natural (in some sense) to predicate one content of another – as is the case where we perceive an accident inhering in a substance. To adopt such a criterion would be to assume, however, that the notion of predication is itself unproblematic: would we, presented with a piece of metal, predicate the character of heaviness of the character of being made of iron, or would we not rather predicate both characters of the underlying substantial object? In the end it is clear that Stumpf does not succeed in resolving this problem. A number of interesting issues are nevertheless raised by this first, halting development of a theory of dependent and independent parts:

The isolation of the concept of mutually dependent, partial contents is, first of all, a fundamental advance over the Humean/Herbartian atomistic assumptions which had hitherto predominated amongst theoretical psychologists. It implies that

in a certain sense neither sensations of place nor sensations of quality are basic. What is properly basic and really perceived are those unified and unnameable contents which continually change and to which, with these changes in mind, we give names such as red, blue, etc. (op. cit., p. 136)

– a view which would indeed subsequently give rise amongst students of Stumpf to a highly successful research programme in the experimental psychology of perception.<sup>30</sup>

Secondly, Stumpf's analyses immediately suggest a thesis – to which we shall return below – that relations of mutual correlation or interwovenness amongst *contents* may correspond, at least in some cases, to relations of mutual correlation amongst corresponding external objects.

And thirdly, whilst all examples considered by Stumpf seem to be a matter of *mutual* or *reciprocal* correlation amongst contents,<sup>31</sup> for example the two-sided reciprocal correlation between colour and extension, or the three-sided reciprocal correlation between hue, brightness and saturation amongst the constituent partial contents in the presentation of a colour, – his work nevertheless leaves open the possibility of distinguishing between such mutual correlation and the *one-sided* correlation

typified by the relation of an accident to the substance in which it inheres. Thus for example there exists a relationship of one-sided dependence between the presentation of a motion, on the one hand, and of the moving body on the other (a body which can of course in principle be presented in a state of rest).

2.2 This distinction between one-sided and mutual dependence was first drawn explicitly by Stumpf's teacher Brentano, and the question here arises as to the possibility of influences between Brentano and Stumpf in this regard.<sup>32</sup> We know that Stumpf discussed his work on presentations of space with his teacher, who was to advance his own views on these issues in works published only later. Unfortunately it is at this stage almost impossible to determine the extent to which Brentano contributed to the account of partial contents developed by Stumpf. Brentano's work on *The Psychology of Aristotle*, published in 1867,<sup>33</sup> contains passages which have a superficial terminological similarity with Stumpf's 1873; for example II,2 "Von den Seelenteilen . . ." and II,4c "Von der bewußten Einwirkung des geistigen Teiles auf den sinnlichen", but the work offers no evidence that Brentano had at that stage grasped the notions of partial content and of mutual dependence in any systematic way.

In Brentano's later works however the notion of one-sided dependence can be distinguished as having played a crucial role.

Consider, first of all, his theory of inner perception, put forward in Book 2 of the *Psychologie vom empirischen Standpunkt*. This rests on a distinction between what Brentano calls *physical phenomena* (colours, shapes, warmth, cold, odours, and similar formations appearing in the imagination), and *psychical phenomena* (the seeing of a coloured object, feeling warmth or cold, every judgment, recollection, expectation, inference, anger, love, hate, desire, act of will, and so on). An inner perception is defined as an act having a psychical phenomenon as its object, an outer perception as one whose object is a physical phenomenon. Brentano's thesis that every consciousness is bound up with a self-consciousness can now be expressed in the form: every act of outer perception is bound up with an inner perception of the act in question. A mental state or event which did not meet this condition would not be a 'consciousness' at all. But it is not as if – as the terminology of 'inner' and 'outer' perception may unfortunately suggest, – this element of self-consciousness is conceived as an additional act which would exist in the mind

somehow alongside the original consciousness. It is, rather, a merely abstractly distinguishable moment of the original consciousness, a (one-sidedly dependent) partial act of a type that can of necessity exist only as embedded within such a larger, circumcluding act-whole.<sup>34</sup>

The second point at which the notion of one-sided dependence can be discerned in Brentano's work is in his theory of evidence.<sup>35</sup> Brentano claims that the only objects of which we can have an absolutely certain apprehension are psychical phenomena, i. e. the acts and states of our own consciousness. Of these alone can we assert with an absolutely evident knowledge that they are in reality as they appear to be in our perceptions of them. Thus whilst, when we are perceiving something given as outside us, we cannot have absolute evidence that the object of our perception is as it seems – we could e. g. be hallucinating, – we *can* know with absolute evidence that this and this particular state of consciousness exists, and that it is structured in such and such a way. Illusions and hallucinations of a kind with which outer perception is indelibly plagued are, Brentano claimed, alien to the world of inner perception.

What he means by this can be explained as follows: absolute evidence is obtained only if a judgment (i. e. the psychical phenomenon) and that which is judged (i. e., for Brentano, that object whose existence is acknowledged or denied), are somehow united in a single whole which is available to consciousness in such a way that the correctness of the judgment can be grasped directly. Experience tells us that such a unity is impossible for judgments of outer perception. Consider, however, judgments of reflexive self-awareness such as 'I am thinking' or 'I have a visual image of a red surface'. Judgmental contents of this sort are, in Brentano's view, merely abstractly isolable moments of more inclusive act-wholes (of thinking, having such and such a visual image, etc.). Thus the desired kind of unity between judgment and that which is judged is here so to speak *already* to hand: our experiences of psychical phenomena are already of themselves experiences having the character of immediate evidence.

The notion of one-sided dependence is discernible further in Brentano's account of the three classes of mental act (of presentation, judgment, and of love or hate/preference or disapproval).<sup>36</sup> Here the structure of the realm of acts is determined by relations of one-sided dependence between the three levels: an act of love or hate is one-sidedly dependent upon an act of judgment (of the existence of the thing loved or hated), which is in turn one-sidedly dependent upon an act of presenta-



tion of that thing. It is as if the act of judgment could be *detached* from, could exist separately from, a moment of love (though not vice versa), and as if the act of presentation could be detached from the moment of judgment (though not vice versa), love and judgment thereby ceasing, in these successive detachments, to exist.

The notion is discernible also in Brentano's treatment of syncategorematic or synsemantic terms (terms whose meaning is one-sidedly dependent upon that of other, categorematic terms).<sup>37</sup> Finally Brentano's theory of double judgments (*Doppelurteile*) rests on the same basis. For Brentano the judgments 'this man is mortal' and 'all men are mortal' contain, respectively, the independent parts 'this man exists' and 'men exist', upon which the remainder of the judgments, which carries the relevant predicative content, is in each case (one-sidedly) dependent. This remainder, not being capable of existing in isolation, is seen as one-sidedly enmeshed, *einseitig verflochten*, in the given constituent judgments.<sup>38</sup> One-sided rather than reciprocal dependence obtains here in virtue of the fact that predication is seen by Brentano as demanding a logically prior judgment (acknowledgment) of the existence of the predicated object, but not vice versa.<sup>39</sup>

**2.3** Brentano's approach, in all of the above, reveals the same basic ontological preference towards a world of (separable or detachable, *ablösbare*) things and their dependent (inseparable or non-detachable) parts.<sup>40</sup> His ontology rests on the distinction between what he calls primary and secondary entities. The former are either things (material things: men, musicians, stones, works of sculpture) or souls; the latter – what Husserl would call dependent parts – Brentano would rather conceive as fictions to be dissolved by analysis.<sup>41</sup> The single important exception to this dominance of one-sided dependence in Brentano's published writings is his analysis of continua. Brentano views continua as things made up of parts, distinguished from collectives by the fact that the parts which constitute the latter are independent things, where the parts which make up a continuum become independent only when separated from the continuum. Both collectives and continua are to be distinguished from things which are not made up of parts in either of these two senses. Brentano's only clear-cut defence of a case of mutual (in fact two-sided) dependence is to be found in his treatment of *boundaries*: the existence of the boundary of a continuum depends upon the existence of the continuum and vice versa.<sup>42</sup>

It can thus be said that where Stumpf's ontology over-emphasises the role of mutual at the expense of one-sided dependence, Brentano errs by over-emphasis in the opposite direction. Only in Husserl's work, to be treated in more detail below, do we find a recognition of the pervasiveness of both one-sided and mutual dependence relations. The difference between Brentano and Husserl expresses itself first of all terminologically: Brentano is interested in detachable (*ablösbare*), i. e. in thing-like parts, Husserl in dependence or inseparability *relations* between parts.<sup>43</sup> In contrast to Brentano, whose ideas here recall the scholastic onion-model of the relation between a substance and its accidents (the successive skins of the onion conceived as surrounding an ultimate, unitary substance not capable of further analysis), – this is seen for example in his discussion of the various types of mental act, in his theory of judgments, and elsewhere – Husserl recognises that acts, sentences, judgments, exhibit internal structures involving ramified relations of mutual dependence, where no element can be picked out as a thing-like core. Thus whilst in his treatment of judgments Husserl agrees with Brentano that the presence of the logical or objectifying quality of positing (the assertive force) is the indispensable criterion for something's being a judgment (see his 5th Logical Investigation), he modifies Brentano's views to the extent of recognising logical or objectifying acts as consisting of four mutually dependent moments (i. e. moments some of which require the existence of others). It is perhaps because Husserl freed himself only gradually from the influence of Brentano's notion of presentation that it was only after the first edition of the *Investigations* that he rejected the view that sentences contain independent (sub-sentential) meanings, i. e. meanings that might in principle make up the content of a complete act.<sup>44</sup>

Brentano's most explicit employment of the ontology of part and whole occurs in his *Kategorienlehre* (1933), a compilation of writings on Aristotelian ideas dating from 1907. Since an admirable discussion of this work exists already in the literature (Chisholm, 1978), we shall content ourselves here with only a brief presentation.

Consider a man standing before a table on which he perceives or imagines he perceives an orange. The man may or may not at any given instant have before his mind an image of an orange. However the man *qua* bearer of such an image is, according to Brentano, a *whole* standing in a relation of one-sided dependence upon the man himself as *part*. The man himself may exist in separation from (*abgelöst von*) the man *qua*

orange-presenter – i. e., in more normal terms, the man would not cease to exist should he cease to perceive the orange – though not conversely. Hence, according to Brentano, we have here a case of one-sided dependence of the orange-presenter upon the man. Note however that the dependent whole is not the result of adding to the independent part some additional, conceptually isolable entity, as is the case within the framework of the classical theory of substance and accident. Indeed Brentano proposes a terminological revision, with respect to this theory, according to which the dependent whole should itself be designated 'accident', accidents in this sense therefore being recognised as including their substances as parts.<sup>45</sup>

This way of conceiving accidents is not without foundation in Aristotle's theory of categories. Aristotle distinguishes not only a (concrete or abstract) *quality*, ποιότης, but also a (concrete or abstract) thus-and-thus *qualified thing* (or substance), ποιόν, both the ποιότης and the ποιόν being listed as categories different from the category of (unqualified) substance (οὐσία). In post-Aristotelian writings, e. g. in Porphyrius, all categories different from that of substance are classified as accidents.

The disadvantage of Brentano's terminology, however, which restricts the term 'accident' *exclusively* to qualified substances, will be obvious. The conceptual pressure exerted by Brentano's view that there exist only what he calls 'things' (men, oranges, perceivers of oranges, etc.) makes it impossible for him to refer, – except in a contrived and round-about way, – to moments, aspects or qualities of things, and thus for him the realm of entities isolated e. g. in scholastic writings on individual accidents, in Stumpf's theory of partial contents, or indeed in the whole corpus of Husserlian phenomenology, becomes inaccessible to scientific investigation.<sup>46</sup> Further Brentano's use of the term 'ultimate unitary substance' (*letzte einheitliche Substanz*), to designate an entity which is contained in all of its accidents as a part, involves, surely, a metaphysical presumption of some considerable magnitude. How could the existence of such a common part be demonstrated? (Cf. Stumpf, 1939/40, vol. I, p. 41).

Despite these problems however it is undeniable that Brentano's use of the part-whole relation, and above all his application of the theory of part and whole in his psychological writings, is of lasting importance. The influence of Brentano's work on dependence relations is particularly discernible in the writings of Anton Marty (another student of Brentano, who had enjoyed a close association with Stumpf in both Würzburg

and Halle), specifically in Marty's development of the opposition between categorematic and syncategorematic terms.<sup>47</sup> Brentano's influence is discernible also in the works of Meinong, Höfler, Twardowski and Ehrenfels. It is however in the early works of Husserl that the truly decisive generalisations on the basis of Brentano's (and Stumpf's) work are effected. It is possible to follow the development of Husserl's thought from his first scattered discussions of various types of *Verbindung* in the *Philosophy of Arithmetic*, to criticism and expansion of Stumpf's insights in the "Psychological Studies on Elementary Logic", culminating in the fully systematic exposition of a completely general theory of wholes and parts in the *Logical Investigations*.

### § 3 Husserl's 3rd Logical Investigation: The Formal Ontology of the Part-Whole Relation

3.1 Stumpf, as we have already seen, drew his examples of dependence relations exclusively from the psychological domain. It was initially in his investigations of the psychology of number that Husserl conceived the idea that such relations, alongside other formal-ontological relations, could be applied completely generally, to all entities and systems of entities whatsoever. Here Husserl's work on functional dependence with his teacher Weierstrass, his discussions on set theory with Cantor in Halle, his study of Schröder's logic and of the Riemannian theory of manifolds, are of importance.<sup>48</sup>

Already in the *Philosophie der Arithmetik* (PdA) of 1891, Husserl had recognised at least four types of relation amongst parts:

(i) the merely *kollektive Verbindungen* (collective combinations) between the separate elements of a group of things tied together only in the weakest possible sense that we think of them as such (e. g. objects on a tray, or on a list);<sup>49</sup>

(ii) purely 'extensive' relations of contiguity, succession, etc., amongst regions of physical space, amongst phases of time, and amongst extensive manifolds and sub-manifolds in other spheres;

(iii) relations of the type which exist between Stumpf's psychological parts (partial contents), but which are now recognised as of considerably wider scope;

(iv) the so-called '*figurale Momente*' (individual relations connecting geese into flocks, trees into avenues, dots into patterns, and so on) simultaneously discussed by Ehrenfels in his 1890.

Brentano, in his lectures of the period, referred to the third type of relation as a *metaphysische Verbindung*<sup>50</sup> (the first type of relation was referred to by Husserl in PdA and in the first edition of the *Logical Investigations* as a 'psychical relation', the second as a 'physical relation'). Metaphysical connections include the relations between the properties of an object, which may exhibit one-sided detachability (as when, for example, the colour of an object loses its lustre) but which are typically a matter of reciprocal interdependence. As Husserl put it (PdA, p. 159), the properties of an object 'constitute a whole of parts which are bound together substantially (which reciprocally interpenetrate)'.<sup>51</sup>

We can point out in passing how recognition of the new type of whole which is generated by such reciprocal interpenetration allowed convincing arguments to be marshalled against Herbart's atomistic concept of substance which, in the course of the 19th century, had achieved a position of some dominance as the official ontology of German psychologists. In defending his view – which has distinctly Tractarian overtones – that the world consists of a plurality of absolutely simple, atomic substances, configured together into complexes, Herbart appealed to the identity theory of the copula, i. e. to the view that the 'is' in '*S* is *p*' is an 'is' of identity. If we interpret this view in what seems to be the most intuitively acceptable way, then we may say that '*S* is *p*' is to be given a canonical expression as:

Some part (or accident) of *S* is identical with *p*,

where '*p*' plays the role of a proper name of some accident, feature or determination. 'Socrates is red', for example, expresses the identity of some part of Socrates with (some individual accident) red. Now, Herbart argues, what is *real*, the substance of the world, cannot have a multiplicity of determinations; for let us suppose that '*S*' denotes such an ultimate substance having the distinct determinations *p*<sub>1</sub> and *p*<sub>2</sub>, i. e. in canonical form:

part of *S*, say *s*<sub>1</sub>, is identical with *p*<sub>1</sub> and part of *S*, say *s*<sub>2</sub>, is identical with *p*<sub>2</sub>.

Now suppose *s*<sub>1</sub> and *s*<sub>2</sub> are non-identical parts of *S*. From this it would follow, according to Herbart, that *S* can be decomposed into a number of different parts. But then these parts are more ultimate, ontologically, than *S*, which contradicts our hypothesis. Hence *s*<sub>1</sub> and *s*<sub>2</sub> are identical, from which follows also the identity of *p*<sub>1</sub> and *p*<sub>2</sub>, again contradicting the initial hypothesis. Hence we must conclude that what is real is absolutely simple.<sup>52</sup> The weak link in Herbart's argument: the as-

sumption that an object  $S$  having non-identical parts  $s_i$  can be decomposed or disassembled into separate individual  $s_i$ , is precisely what is called into question by the recognition of *metaphysische Verbindung* amongst parts and by the denial of the thesis that every whole is a mere sum of pieces.

Brentano acknowledged also a further type of part-whole relation in his early lectures, which he called a *logische Teilungsverhältnis*. In echo of Peter of Spain's third and fourth *modes of being in* (see § 1.2 above), this is conceived as a relation between moments corresponding to the logical relation of species to genus. A particular instance of red, for example, is, even abstracting from its spatial extent and leaving aside its constituent hue, brightness, etc., non-simple from the point of view of its logical parts. For in the abstractum *red* there lies the moment *colour*. But it is not as if colour is somehow filled out to become red by the adjoining of some further moment. Colour rather specifies itself in red. The latter *is* colour, and yet is not identical with colour.<sup>53</sup>

3.2 Whilst at the time of PdA Husserl had no more than a rudimentary theory of part-whole relations as such, he moved progressively toward such a theory in his writings between 1891 and 1900, the year of publication of the 1st volume of the *Logical Investigations*. By this time he was in a position to put forward a perfectly general '*a priori* theory of wholes and parts, i. e. of forms of connection (*Verbindung*) and unity' (Husserl, 1913, p. 131), laws valid not only in the field of descriptive psychology (i. e. purely amongst mental contents), but for all objects whatsoever.

These laws are presented in a highly compressed form in the 3rd Logical Investigation, a work which is, for all its inadequacies, the single most important contribution to realist (Aristotelian) ontology in the modern period. Its significance was understood by Husserl's most immediate followers – particularly the members of the Munich-Göttingen school of phenomenology (see the work by Reinach translated below) – but this understanding waned amongst subsequent generations of thinkers around Husserl, despite the fact that he himself recommended it to his students as central to the understanding of both the remaining Investigations and of his later phenomenology.<sup>54</sup> It has nonetheless, as we shall see in the sections which follow, exerted a not inconsiderable influence on the thought of the twentieth century.

The Investigation begins by quoting with approval Stumpf's<sup>55</sup> definition of partial contents as contents whose nature forbids them to have an

isolated and mutually independent existence in our presentations (Stumpf, loc. cit., p. 113). Husserl states however that he intends to use this definition only as a starting point for a more precise definition of the concept of dependence, one which will be at one and the same time free of the drawback of relativisation to subjective capacities for presentation (as in Stumpf's original theory) and allow a generalisation of the concept of dependence beyond the purely psychological sphere.

To say that a content can be presented 'in isolation' clearly cannot mean that it 'can be freed from *all* fusion with coexistent contents, can therefore ultimately be torn out of the unity of consciousness altogether' (LU III, § 5) – for *all* mental contents are inseparable in this sense; all presentations are presentations against some co-presented background or other. Isolability, Husserl concludes, can only mean something like: capable of being held constant in presentation under conditions of absolutely free variation,<sup>56</sup> within the limits set by the nature of the content in question, of all contents associated with it, so that it should indeed in the end, but only in principle, remain unaffected by the very elimination of such contents.

This self-evidently entails that the existence of this content in presentation and in consciousness generally is not at all conditioned by the existence of other contents, that it could exist, just as it is, even if there were in consciousness nothing at all beside it, or even if everything about it should vary arbitrarily, i. e. without principle (loc. cit.).

But this implies that the content is in itself such that there is rooted in its nature no necessary interwovenness with other contents.

Now a content which in itself is such that its ideally graspable essence, its intrinsic structure, that which makes it what it is, also 'leaves it unconcerned with' all other contents is called by Husserl independent (*selbständig*). A content which in its ideally graspable essence or nature is bound to other contents, which cannot be if other contents are not there together with it, he calls dependent (*unselbständig*).<sup>57</sup>

With this shift from talk of 'possibilities of separate presentation' to talk of intrinsic essences or natures (intrinsic structures) of the contents involved, Husserl has eliminated from his definition of dependency all reference to the conscious subject, except incidentally – the conscious subject is someone who may potentially grasp by a process of imaginative variation the essences in question.<sup>58</sup> And all references to 'differences in mode of presentation' have also been eliminated. Husserl has,

in other words, departed considerably from Stumpf's (and the traditional, e. g. Berkeleyan) account of independence as signifying that a content is capable of being presented in isolation from other contents. He has moved much more closely to the position of the scholastic realists, to the concept of independence as an objective character of contents capable of existing in isolation from other contents.

Simply by substituting the word 'object' for 'content' in this account it now becomes possible to effect an immediate generalisation of the dependence/independence opposition beyond the purely psychological sphere to apply directly, in reflection of what Husserl calls a 'universal ontological difference' (§ 9), *to all entities whatsoever*. Just as a presentation of colour cannot exist in isolation from a presentation of space, so a *reconciliation*, say, cannot exist in isolation from a prior disagreement, an *answer* cannot exist in isolation from a prior question, a *husband* cannot exist without a wife, a *sales representative* cannot exist without the company he represents and goods to be sold. Such dependence relations amongst parts correspond, we shall argue, to systems of *a priori* truths.<sup>59</sup>

**3.3** Husserl's theory of whole and part is a theory which makes room for both independent and dependent parts. We are already familiar with many examples of the former (the items of furniture which make up the everyday world are all of them independent parts – in the sense that each could continue to exist even though all the others should go out of existence). The independent parts of a whole such as, for example, a sheet of glass, coincide with the extensive parts of such a whole as these are determined, e. g. by Leśniewskian mereology or by the calculus of individuals (or by breaking the sheet of glass into smaller pieces). But it is not as though Husserl, with his distinction between dependent and independent parts, is presenting what is in the end merely a theory of extensive parts of the familiar (mereological) sort, to which is conjoined an additional, in principle dispensable, capacity of recognising particular esoteric marginal cases of ('non-extensive') parts enjoying logically peculiar properties.

To make this clear consider, again, the sheet of glass *s*, which is uniformly red (has a uniform red-moment – dependent part – *r*, inhering in it), and is recognisable as being decomposable, e. g. by careful slicing, into two specific smaller sheets, *s*<sub>1</sub> and *s*<sub>2</sub>. Clearly in such circumstances *r*, too, must be recognised as being decomposable into two correspond-



ing constituent red-moments  $r_1$  and  $r_2$ , inhering in  $s_1$  and  $s_2$  respectively. The same considerations clearly apply equally to non-homogeneously coloured bodies. And they apply further to moments extended not through space, but through time: knighthoods, for example, or diseases, or bonds of wedlock. Thus consider a man  $m$  and a woman  $w$  joined together by the specific bond (two-place relational accident)  $b$  of holy matrimony existing between the two of them across the specific interval of time  $t$ . Here again, the bond (unifying moment)  $b$ , existing in some given proper extensive part  $t_1$  of  $t$  is surely an extensive part or *phase* of the moment  $b$ .

According to Husserl, extensive moments, whether spatial or temporal, and moments founded on them have the property which no other moment has of being pieceable. Thus the examples given show that even in the superficially non-extensive sphere of dependent parts we are able to establish – effectively by drawing (or recognising) *boundaries* – extensive relations of part to whole, i. e. that *there are moments which have pieces* (cf. § 17, where Husserl also gives a precise sense to what we have here loosely designated ‘extensive part’). Pieces of moments may in turn possess moments of their own, which may in their turn be recognisable as decomposable into further pieces or as the bearers of further systems of moments, and so on, without any generally establishable limit.

Husserl’s theory of extensive and non-extensive wholes differs from a two-sorted theory (mereology supplemented by the facility of recognising moment-whole relationships) in acknowledging the existence, as it were below the surface level of everyday reality, of a hierarchically organised sequence of banks of moments and pieces reticulated amongst each other in complex ways.<sup>60</sup> But that is not all. There is also a certain sense in which moment-whole relations can be established also in strata (in universes of discourse) as it were *above* the level of everyday reality. To these belong all ‘syntactic unities’<sup>61</sup> (words, sentences, scientific theories, and perhaps sets, classes, . . .), all of those entities designated by Meinong (1891; 1899) as *objects of higher order*, all institutional entities, and so on. The head of corporation  $c$ , for example, *qua* head of  $c$ , is not a mere *piece* (independent part), since of course should the remainder of the corporation cease to exist then he too (in his capacity as its head) will also pass out of existence. This is not to deny that the moment of  $c$  which is its head is not – in the relevant interval of time – coincident with the independent whole which is the corresponding human being. But coincidence is not identity, as the proponents of an exclusive-

ly extensionalist ontology – for whom all strata collapse onto a single stratum (the isolation of which is presumed to be somehow unproblematic) – would have us believe.

If we say, with Meinong, that a higher order object such as a melody is *founded* upon its lower order *fundamenta* (in this case the individual tones), then this is just to say that these fundamenta constitute a whole of parts which do not merely exist together side by side.<sup>62</sup> They are, rather, ravelled together in virtue of the tendency of each tone to set up expectations as to the order of its successors and to consolidate an order in our memory of the preceding tones. The higher order object which is a session of the Austrian Imperial Council is a whole of parts: statements, questions, answers, orders, standings up and sittings down, ravelled together both by the complex of interrelations between these elements themselves, and by the relations between these elements and events outside the Council. From this conception it follows, trivially, that two different higher order objects (a football team and a submarine crew) may have identical constituents (ravelled together in different ways). And it follows also that to dispose of a higher order object such as a family, a philosophical movement, a nation or a culture, it need not be sufficient merely to separate its parts: these parts must also (if this is possible) be unravelled.

3.4 Husserl's discussion of the upwards and downwards piece/moment hierarchy is in the very important § 13 of the 3rd Investigation, on "Relative Dependence and Independence". A given visual moment of extension  $e$  is, as we have already seen, dependent, within the sphere of mental contents, on a co-perceived moment of colour (or configuration of such moments). The fact that we can distinguish, extensively, constituent  $e_i$  (by drawing arbitrary boundaries), that we can imagine the remainder of  $e$  disappearing whilst any given  $e_i$  is held fixed in presentation, signifies that the  $e_i$  are independent, – but only relatively to the whole  $e$ . They are not, of course, absolutely independent, since each  $e_i$  is, like  $e$  itself, dependent upon moments outside the realm of visual extent: we cannot imagine a given visual extent remaining fixed in presentation whilst *all* visual filling (i. e. all colour-data) should disappear.

Within, and relatively to, the concrete totality of a momentary visual intuition, each portion of our visual field, each concretely filled section of it, is independent; each colour of such a portion, the colour-pattern of the whole, etc., is de-

pendent. And again, in, and relatively to, the whole of our momentary total sense-intuition, the visual field with its contents, the tactual field with its contents, etc., are independent, whereas the qualities, forms, etc., whether attaching to whole fields, or to their individual members, are dependent (§ 13).

Relative to the summative whole *words of the English language*, the words of this sentence are independent pieces; relative to the sentence itself they are dependent moments. Relative to the whole which is the object-world depicted in a given novel, the characters of the novel are independent pieces; relative to any whole which includes the totality of experiences of readers of the novel, these characters are merely abstractly distinguishable dependent moments. Relative to the world as a whole (that is to say *absolutely*), the Hamburg representative  $v$  of a São Paolo coffee trading company is independent (the company could cease to exist without this bringing about the annihilation of its representative as an item of the furniture of the world); relative, however, to any whole in which  $v$  functions essentially *as* a representative – e. g. to a complex of events in which  $v$  signs contracts, makes commitments, fulfils obligations in the name of his principal, etc., –  $v$  is a dependent moment – (should the company cease to exist then this would, of necessity, bring about the consequence that  $v$  too, *qua* agent of the company, would cease to exist).<sup>63</sup>

This last example suggests a sense in which dependence-relations may occur between wholes which are spatially or temporally disparate, or between wholes from distinct ontological regions.<sup>64</sup> A husband *qua* husband is dependent upon a certain other human being (his wife), in that should she cease to exist then he too, of necessity and of his very nature, would thereby also cease to exist: a husband (master, king, employer, slave-owner . . .) as such cannot exist except in a more comprehensive unity which associates him with a wife (servant, subject, employee, slave . . .).

**3.5** The types of dependency relations which have been recognised so far include:

that type of dependency which holds between a husband and a wife (or equally, for our present purposes, between a claim and a mutually correlated obligation, or between the north and south poles of a magnet);

that type of dependency which holds between a higher order whole and its lower order *fundamenta* (for example, between a sentence and

its words, between the *natio hungarica* and the totality of Magyars, or between the institution of holy matrimony and the totality of wedlock bonds);

that type of dependency which holds between an answer and a question, between a reconciliation and a disagreement, between the fulfilment of a promise and an act of promising, and so on.

Without here attempting more than a rudimentary classification,<sup>65</sup> we might instance also the following additional examples of dependency relations:

the mutual dependence of the purely (abstractly isolated) psychological parts of the whole which is a thinking human being, and the purely physical (biochemical) parts of the same whole;

the one-sided dependence of a 10 Mark note *qua* sum of money upon the relevant *readiness to accept* distributed across a given population; of the human race *qua* extant biological species upon a specific system of climatic and other environmental conditions;<sup>66</sup> of the scientific character (originality, rigour, etc.) of the products of a given academic community upon a specific system of economic and institutional rules, customs and conventions, to which its members are subjected; and so on.

In order to be able to express in a completely general way the character which is shared by all possible dependence relations, Husserl reintroduced Meinong's terminology of foundation, though he endowed it with a different sense: a husband, as Husserl would now express the matter, is *founded upon or through* or *requires foundation by or in* a wife (§ 14).

**Definition:** If there is a law of essence that an  $\alpha$  as such cannot exist except in a more comprehensive unity which connects it with a  $\beta$ , then we say that an  $\alpha$  requires foundation by a  $\beta$  (*loc. cit.*).<sup>67</sup>

He then elaborates a series of highly general laws in which insights deriving from the work of Brentano and Stumpf and from the Aristotelian doctrine of substance and accident, from the Boole-Peirce-Schröder algebra of logic and the theory of formal manifolds initiated by Herbart and Riemann, and from the discussions of part-whole relations in Bolzano's *Wissenschaftslehre* and in Twardowski's *Zur Lehre vom Inhalt und Gegenstand der Vorstellung*, are welded together in a single formal ontological system.

These laws are expressed in terms of the concept of foundation as defined above. We shall quote them in full as a basis for discussions in later papers in this volume.<sup>68</sup>

**Theorem I:** If an  $\alpha$  as such requires foundation through a  $\beta$ , then every whole having an  $\alpha$  but not a  $\beta$  as part requires a similar foundation.

**Theorem II:** A whole which includes a dependent moment without including as its part the supplement which that moment demands, is likewise dependent, and is so relative to every superordinate independent whole in which that dependent moment is contained.

**Theorem III:** If  $a$  is an independent part of (and thus also relative to)  $b$ , then every independent part  $c$  of  $a$  is also an independent part of  $b$ .<sup>69</sup>

**Theorem IV:** If  $a$  is a dependent part of a whole  $b$ , it is also a dependent part of every other whole of which  $b$  is a part.

**Theorem V:** A relatively dependent object is also absolutely dependent, whereas a relatively independent object may be dependent in an absolute sense.

**Theorem VI:** If  $a$  and  $b$  are independent parts of some whole  $c$ , they are also independent relatively to one another.

The reader is referred to the first of Simons' three papers below for a discussion of Husserl's proofs of these theorems and for a detailed indication of their interrelationships and consequences. In presenting these theorems Husserl is concerned to stress that, despite the vast number and complexity of materially different types of part-whole relation, there exists nonetheless a system of formal *a priori* relationships, both between parts and their circumcluding wholes and amongst the various levels of systems of parts of a single whole, and that these relationships generate *a priori* laws relating, for example, to the relative nearness and remoteness of parts from each other (§§ 18–20), to the possible structures of temporally ordered wholes (§§ 14, 25), or to the processes of decomposition or *piecing* of wholes (§§ 17, 25). And he is concerned to stress also that continual tacit appeal is made to such *a priori* relationships in our everyday and scientific talk of different sorts of wholes and

parts. The remainder of his Investigation is devoted to the development of the formal ontological theory of these *a priori* relationships and to the provision of sketches of applications of the theory to specific material regions (above all, still in the shadow of Stumpf, to the region of mental acts and their contents and, in the 4th Logical Investigation – see § 5 below – to the region of grammatical part-whole relationships).

#### § 4 The Theory of Material *A priori* Structures; Phenomenology and Formal Ontology

4.1 'It is evident to anyone who makes the attempt that it is impossible that we could present to ourselves either extension without colour or colour without extension' (Stumpf, 1873, p. 109). This passage, together with the similar passages quoted in § 2 above, points to the existence of an *a priori* order in the domain of perceptual contents. In marked contrast to the associationistic elementarism still dominant amongst psychologists in Stumpf's day, according to which it should be possible, at least in principle, to establish or disestablish connections between *any* mental contents whatever, the arguments advanced by Stumpf suggest that there is a (perhaps highly complex) system of *a priori* structural conditions of possibility amongst such contents.<sup>70</sup>

This *a priori* order shows itself most straightforwardly in the relationship of three-sided foundation between the specific hue, brightness and saturation of an individual colour-datum, between the specific constituent moments of pitch, timbre and loudness of an individual tone, or between the distinctive features of an individual phoneme.<sup>71</sup> Such relationships may be illustrated, in simple cases, as follows.<sup>72</sup>

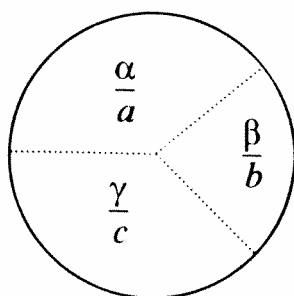

The validity of these abstract decompositions, which were originally discovered by *a priori* analyses (cf. above all the work of E. Hering),<sup>73</sup>

was overwhelmingly established, with amendments for specific variant cases, by a vast amount of empirical work undertaken in the early, seminal decades of experimental psychology. It was demonstrated, from a number of distinct perspectives, that each of the constituent moments that had been distinguished reflected an axis of independent variation in the nature of (a distinct dimension in the geometry of<sup>74</sup>) perceptual contents of each specific type.

The question immediately arises as to whether it would be possible to give corresponding resolutions, i. e. corresponding systems of foundation relations amongst abstractly distinguishable moments, for mental contents of other types, e. g. for the contents – if this is here still an appropriate term – associated with acts of volition, with emotions, with mental processes of thinking, judging, inferring, remembering and so on. Husserl's answer to this question was of course an affirmative one, and indeed Husserlian phenomenology can be most illuminatingly characterised as the working out of the thesis that *a priori* laws of foundation,  – type analyses, can be provided for *all* mental contents, however complex.

There are in addition passages in the *Logical Investigations* which demonstrate that – at that stage at least – Husserl believed that *a priori* laws of foundation can ultimately be provided not only for mental contents but for objects in general, including events, actions and processes in the material world. This view was extended to apply to the objects of scientific disciplines, of history, of literary theory, and so on, by the members of the Munich-Göttingen circle of phenomenologists in their now sadly neglected contributions to applied phenomenology (see e. g. Schmücker, 1958). Husserl's claims also provoked Stumpf, in his Berlin Academy Lecture "On the Demarcation of Scientific Disciplines" (1906a), to advance a compromise position according to which there are indeed a limited number of what he called *Vorwissenschaften*, relating to domains – including the domain of sense-contents – which are characterised by subjection to *a priori* foundation relationships, but that sciences proper, except insofar as they rest on principles derived from the given *Vorwissenschaften*, have to deal with non-*a priori* features of the world which can be determined only empirically.<sup>75</sup>

It is our business in this essay only to point out in broad terms the nature and influence of the theory of dependent and independent parts developed in particular by Husserl. We shall therefore seek neither to estab-

lish the rights and wrongs in this specific methodological issue, nor to examine in detail Husserl's claim to have established, in his investigations of the phenomenological structure of conscious experience, a vast new realm of *a priori* relationships.<sup>76</sup> It will be interesting, however, to survey some of the ways in which the theory made itself felt in the development of Husserl's thought, taking as our basis the hypothesis that, as a matter of fact and of principle, all propositions of phenomenology are expressions of what we shall call material *a priori* connections between moments,<sup>77</sup> are capable of being perspicuously represented within the framework of the theory of part and whole.

This applies first and foremost to the individual analyses of phenomenology, i. e. to the analyses of acts of perception, of memory, of predication, and so on. It can however be extended also to some of Husserl's metaphysical claims, for example to the claim that all regions of being are dependent (i. e. are one-sidedly founded) on the region of transcendental consciousness.<sup>78</sup> Consider also two important criticisms Husserl made of Kant: that he conceived of the faculties as pieces (*Stücke*); and that he failed to see that every genuine *a priori* proposition, whether analytic or synthetic, becomes counter-sensical (yields *Widersinn*) when negated.<sup>79</sup> In the first of these criticisms Husserl is drawing attention to the fact, missed by Kant, that despite the apparent transience and plasticity of the phenomena of consciousness, there is nevertheless an *a priori* system of intrinsic interrelationships amongst these phenomena which is capable of being disclosed. An act of joy, for example, presupposes an act of grasping a state of affairs of a specific type; an act of memory presupposes a temporally ordered sequence of acts in which it is rooted in a quite specific way, and so on.<sup>80</sup>

The phenomenologist, independently of his metaphysical position, recognises that acts of consciousness do not form a self-contained region (*Weltstück*) isolated from the region of external objects (including living bodies), from the region of human action, or from the region of linguistic structures, but are, rather, reticulated with these in myriad ways. Hence his analyses will typically be directed towards more than one single region; the material *a priori* *Sachverhalte* that he discloses will often straddle the boundaries between regions.<sup>81</sup> They are, nevertheless, objective constituents of reality.<sup>82</sup> Their aprioricity (or intelligibility) is not the result of any conceptual, linguistic or grammatical convention. This implies an *ontological* approach to the problem of the *a priori*, – an approach which stands in opposition to the logico-linguistic



approach, inspired above all by Frege, which has come to be accepted as orthodoxy by Anglo-Saxon philosophers.

Whilst for Husserl the *a priori* of judgment and the *a priori* of *Sachverhalte* are viewed as two sides of a single coin,<sup>83</sup> his disciple Reinach viewed the linguistic *a priori* as derivative of the material *a priori*. That 'orange lies between red and yellow in the order of similarity' is an *a priori* proposition, results from the fact that orange, red and yellow are themselves thus ordered in the region of colours.<sup>84</sup> Reinach argued indeed, particularly in his *On the Theory of the Negative Judgment* (translated below) that this priority of the *Sachverhalt* over correlated sentence, judgment or proposition implies the need for a new, ontological foundation of logic. Mutually contradictory judgments or propositions, for example, *are* mutually contradictory, according to Reinach, in virtue of the ontological incompatibility of the corresponding *Sachverhalte*.<sup>85</sup>

The reconciliation of Hans and Erna is founded upon their (temporally prior) conflict of opinion or conduct; the later event is, as a reconciliation, of necessity bound up with (its existence is dependent upon) the earlier.<sup>86</sup> The three moments founded in Fritz which consist in (1) his *refuting Popper*, (2) his *writing a book*, and (3) his *going to the library every day* form, with Fritz himself, a whole whose structure is such that (3) is the *means* for (2) as end, where in its turn (2) is the means for (1) as end. The complex temporally extended moment which is the daily visit to the library is such that it is essentially possible for it to found the writing of a book. It is, in contrast impossible for the writing of a book to found the visit to the library, as is reflected in the absurdity of *Fritz goes to the library every day by writing a book*.<sup>87</sup>

**4.2** The fact that the world, in all its strata, is thus criss-crossed with a multifarious system of material *a priori* foundation relations has an important consequence for the theory of individuation. Traditionally the assumption has been that it is the spatio-temporal coordinates of an object, event or process which are to be taken as yielding its principle of individuation.<sup>88</sup> If, however, every object is, independently of any relation it may bear to the co-ordinate systems of space and time, to be recognised as traversed also by networks of essential interrelationships of other kinds (depending on its own specific nature), then it may prove that space and time fail to provide sufficient conditions for individua-

tion: Wolfgang's *jumping up and down in a frenzy* and his *getting warm* may occupy an identical spatio-temporal extent, but in such a way as to be embedded in distinct systems of surrounding *Sachverhalte*.<sup>89</sup> Such objects are, in the terminology introduced above, *coincident* but not *identical*. The way in which the concept of spatio-temporal location applies to the objects of scientific disciplines (phonemes, molecular structures, animal species, . . .) differs from the way in which the concept applies to the medium-sized durables in a speaker's perceptual environment, and this differs in turn from the way in which the concept applies to institutional and cultural artefacts such as legal persons, joint stock companies, brands of coffee.<sup>90</sup> These ideas, which Husserl regarded as 'a first decisive step in the division of *a priori* ontologies'<sup>91</sup> are taken up again in his later writings on regional ontologies.<sup>92</sup>

There are many different types of unifying relations, both within a single object – relations which constitute that object into a relatively isolated, integrated whole,<sup>93</sup> – and between objects – relations of causality,<sup>94</sup> for example, or of submission or respect. Systems of unifying relations within an object correspond to predicatively formed *Sachverhalt*-complexes; systems of interobjectual unifying relations generate networks of relational *Sachverhalte* which rest, in the end, upon purely formal (content-less) relations of foundation. As Husserl puts it: "Alles wahrhaft Einigende . . . sind die Verhältnisse der Fundierung".<sup>95</sup> That is, all that is truly unifying are relations of foundation. Such a content-less foundation is necessary, since otherwise the classical infinite regress – familiar from the Third Man argument, from the work of Bradley, Russell, Stout, *et al.*, on internal relations,<sup>96</sup> or from Bergmann's defence of his nexus of instantiation<sup>97</sup> – is threatened. Suppose *a* and *b* stand to each other in the external relation *r* (not a relation of foundation). Then further relations, *r'* and *r''*, must exist to connect *a* to *r* and *r* to *b* respectively. Now either *r'* and *r''* are ultimate relations of foundation or again further relations *r'''*, etc., are needed to colligate these with their respective relata. Foundation relations put a stop to this regress, since only contents can have a foundation, not foundation relations themselves.<sup>98</sup>

The logic of foundation is used by Husserl not only in the *Investigations* but also in his later works, for example as an indispensable means of displaying the structure of inner time,<sup>99</sup> of material objects,<sup>100</sup> of the sensory plenum,<sup>101</sup> and in his theories of pure grammar (discussed in § 5 below). Here we shall concentrate on his employment of the theory in

giving an account of the structure of mental acts, including (linguistically borne) acts of predication.

As for Brentano, so also for Husserl, mental acts may exhibit a peculiar many-layered or stratified structure. Thus:

The subject-member of a categorical asserting is an underlying act, a positing of a subject, on which is built the positing of a predicate, its attribution or denial. Just so the antecedent of a hypothetical assertion constitutes itself in a clearly demarcated part-act, on which is built the conditioned positing of the consequent . . . On such a composite act (whose members may in turn themselves be composite) a new act may be built, e. g. an act of joy built on the taking in of a state of affairs, a joy about that state of affairs. The joy is not a concrete act in its own right, and the judgment an additional act alongside it: the judgment is rather the founding act for the joy, it determines its content, brings to realisation its abstract possibility – for without some such foundation (in the strict sense of our 3rd Investigation) there can be no joy at all (LU V, § 18).<sup>102</sup>

The concept of stratification was most fully exploited, within the phenomenological movement, by Roman Ingarden, particularly in his theory of the literary work of art (1931).<sup>103</sup>

An act, according to Husserl, possesses a *matter* and a *quality*. The act-quality stamps the act as a judgment – and so involving positing – or as a mere presentation, as an emotional act, an act of doubt, etc. The act-matter is simply the content of the act which determines it as a presenting of *this*, as a judging of *that*, etc. (LU V, § 20). According to Husserl,

the act-quality is undoubtedly *an abstract moment of an act*, something that would be utterly unthinkable detached from all matter. Or should we perhaps hold an experience possible which would be a judgment-quality but not the judgment of some definite matter? The judgment would after all thereby lose its character as an intentional experience, a character which evidently belongs to it essentially.

The same will hold of matter. A matter that was not matter for presentation, nor for judgment, etc., will be deemed to be unthinkable (loc. cit.).

Thus the distinction of matter and quality is a distinction amongst mutually founding act-moments, and that *every* act has both matter and quality can be asserted as a material *a priori* truth.

Part-whole relations enter into Husserl's account of the coherence of series of acts and partial acts and into his account of the way these coincide or conflict with the objects or states of affairs toward which they are directed.<sup>104</sup> They enter, in particular, in his account of the 'mutual

belongingness' of signitive acts of empty intention and the intuitively filled acts in which they find their fulfilment (LU VI, § 8), in which, that is to say, 'the intentional essence of the act of intuition gets more or less perfectly fitted into the semantic essence of the act of expression' (loc. cit.).<sup>105</sup> We shall return again to this logic of fitting below.

Every act, as a matter of *a priori* necessity, has a moment of fulfilment of some specific degree. It is clearly important to note that fulfilment may be 'more or less perfect' – may, indeed, be totally imperfect, when an act of signitive intention is wholly frustrated by a conflicting intuitive content. Typically it is *partial fulfilment* (and therefore sometimes also partial frustration) with which we have to deal. An intention can be fulfilled in an act which contains either *more* or *less* than its fulfilment (in the sense of total agreement) would demand. The fulfilling act may offer merely a part or moment of that total content which would be required to achieve a perfect fitting, or it may offer an object or state of affairs which itself properly includes as part or moment the object of the original intention (cf. LU VI, § 12 which contains a valuable discussion of the syntheses involved in partial fulfilment).

Perfect fulfilment is possible in virtue of the fact that wherever simple acts (of, say, perception or judgment) are interwoven into more complex acts (of joy, surmise, doubt, questioning, wishing, etc.), corresponding interweavings are established also on the object-side amongst the intended objects and states of affairs of the corresponding acts and part-acts. That total state of affairs the intuitive grasp of which fulfils, a hypothetical judgment<sup>106</sup> has an objectual antecedent-consequent structure corresponding to the logical antecedent-consequent structure of the judgment itself. A wishful intention finds its fulfilment only when a mere presentation of the thing wished for becomes transformed into a corresponding perception (LU VI, § 13, and cf. Duncker, 1941).

There are, therefore, manifold ways in which acts may be combined into other acts (and correspondingly manifold ways in which objects may be combined into higher-order act-correlates). Yet whilst

the briefest consideration shows that in the ways in which acts are interwoven with each other or are founded upon underlying acts which open up the possibility of their realisation there are striking differences, the systematic investigation of these differences . . . is as yet hardly in its beginnings (LU V § 18).

In particular the formal ontological *theory of fitting* (of part-acts into total acts, or of part-objects into total objects, or of isolated cognitive

endeavours into the totality which is a scientific theory: see the essay by Willard below) has been denied attention by mathematicians and formal ontologists to the benefit of other, related yet distinct formal-ontological disciplines.<sup>107</sup>

4.3 The context in which whole-part theory is treated in *Experience and Judgment* differs from that of the *Investigations*.<sup>108</sup> Husserl here takes up again the problem of the relations between acts (or series of acts) and their objects (*qua* act-correlates), and sets out a detailed account of the interrelations between

- i) the phenomenological structures of series of acts and partial acts in which something is made thematic,
- ii) the logical form of propositions in which this being-made-thematic is expressed,
- iii) the ontological form of the objects and object-parts involved therewith.

But it is for the sake of the theory of pre-predicative (perceptual) and predicative explication that this account is provided. *Wie diese Sachen sich zueinander verhalten*, that is, how the phenomenological, logical and ontological features of our experience complement and constrain each other, is elucidated as part of a general theory of the basis and role of predication in experience.

Objects are thematised for the sake of predication: the objects serve as substrates for the determinations brought into play through acts of judgment.

The distinction between substrate and determination shows itself at first as purely relative. Everything that affects and is objective can just as well play the role of object-substrate as that of object-determination or explicate. And just as we can, continuously and at ever higher levels, make explicates independent and thus make them into substrates . . . in the same way we can also colligate every object, every autonomous substrate, with other objects, and then make the collection as a whole into a theme, enter into its members by explication, in this way exhibiting the whole by determining it, so that each of the formerly independent object-substrates henceforth acquires the character of explicate (E & U, § 9).

It is however possible, by appeal to the concept of mediate and immediate part elaborated in LU III, to recognise not only a relative distinction between substrate and determination, but also *absolute substrates* (im-

mediately experienceable independent wholes) and *absolute determinations* (dependent moments which appear only as such).<sup>109</sup>

Husserl also discusses the distinction between the 'is' of predication ('*a* is triangular'; '*a* is an instance of the species *triangularity*') and the 'has' of judgments such as '*a* has triangularity'. A predicate may correspond to either a moment or a species.<sup>110</sup> Not every moment, however, corresponds to a predicate. The scope of 'moment' is, in other words, much greater than that of 'property' understood in the sense familiar to analytic philosophers as the sort of entity to which a predicate expression can correspond. Examples of moments which are not properties in this sense include first of all the dynamic moments discussed in § 1.2 above. But they include also certain static moments; for example, the edge of a material thing, or its total surface. In general, every boundary is a dependent part of the object it bounds (in virtue of the fact that it cannot be removed from the object in such a way that two separate pieces are thereby created). Yet a boundary is not a property of the object it bounds. One possible view suggested by Husserl (E&U, § 32a), would be to regard the boundary as in some sense a non-immediate property of its object. Thus the specific individual extendedness or spatial *Gestalt* (or extendedness-distribution over time) of an object is an immediate property of that object. If, now, we can regard this specific individual extendedness as having as its immediate properties the relevant boundaries (edges, surfaces, etc.), then the latter become recognisable as mediate properties of the original object.

**4.4** We conclude this section with some remarks concerning the innovations of Husserl's work in whole-part theory. These innovations centre around the recognition on Husserl's part of *ontological structure*; relations of foundation are seen not, as in Stumpf or Twardowski, as exclusively a matter of relations amongst mental contents, nor, as in Schlick and Wittgenstein, as a matter of grammar. They are, rather, necessarily all-pervasive, extending through *all* material ontological regions, including both the linguistic and the psychological.

More specifically, we can identify the following advances made by Husserl over the Aristotelian theories of parts and wholes, including those developed by Stumpf and Brentano, that had preceded him:

- 1) the replacement of conceivability restrictions on mental contents by ontological relations holding independently of conceivability (independently of all cognition);

2) the recognition of whole-part theory as a formal ontology (applying to all matters and thus not e. g. to mental contents only), a formal ontology distinct from and more inclusive than formal logic (cf. LU IV, § 14; cf. also Smith, 1981 a);

3) an account of the piecing of moments of extension and of the radical differences between moments of extension and other moments (Brentano comes close to making the same distinctions in his 1978);

4) an account of what a formal, as opposed to a material concept is; recognition that foundation is a formal concept;

5) an elaboration of example-domains for whole-part theory to include both bi- and multilateral foundation relations. Where, in traditional discussions of the synthetic *a priori*, the focus has been almost exclusively on propositions of the form 'If  $x$  is  $P$  then  $x$  is  $Q$ ' (that is, on propositions expressing relations between predicates holding of a single object), or universalisations thereof, Husserl recognised the ubiquity of synthetic *a priori* relations amongst object-pluralities (for example, amongst the specific hue, brightness and saturation of a given colour); such relations pose crucial problems for the traditional approach, even in its modern semantic formulation, since they may involve objects falling under no common determinable (cf. Husserl on *disjunct parts*, LU III, § I, esp. 1st ed.).

6) the emancipation of philosophical ontology from the metaphysical dichotomy of atomism/holism (as propounded by, respectively, Herbart and Wittgenstein, and Spinoza and Bradley);

7) the development of a formal ontology of meanings: where, in the *Tractatus*, meaning (sentence sense) and *Sachverhalt* have an identical formal multiplicity, in the *Logical Investigations* meaning and *Sachverhalt* merely have the same sort of multiplicity, i. e. both involve foundation relations;

8) the extension of the theory of wholes and parts by means of a logic of fit, to describe exemplification and verification (fulfilment, frustration) of sentences (sentence-using acts): epistemology becomes a descriptive science (LU VI);<sup>111</sup>

9) a description of what it is for an object to be a simple object within some cognitive/theoretical frame, avoiding the pitfalls mentioned in (6), (E&U, § 29).

The ontological structure, both formal and material, uncovered by Husserl has been obscured to philosophers working within the analytic tradition primarily in virtue of the unargued identification of the *formal*

with the formal *logical*. Once the distinction between formal logic (i. e. formal theory of meaning-connections) and formal ontology (formal object-theory) is clearly drawn, then it becomes possible to recognise also material connections both amongst meanings and amongst objects.<sup>112</sup> It has been part of our purpose here to demonstrate that there is nothing intrinsic to the analytic method that should impede the recognition of such structure and therewith the adoption of Husserl's view that the formal (matter-independent) relations of part to whole are capable of founding a general and non-trivial ontological theory of the structures exhibited not only by mental acts and their contents, by observables and by linguistic complexes, but also, in principle, by the objects of every scientific discipline.

As a partial illustration of this claim we now turn to an area where Husserl's theory has already exercised considerable influence, and where there is good reason to think that the theory will sustain further exploitation: the formal study of meaning in logic and linguistics.

#### § 5 The Influence of the *Logical Investigations* on Logical Grammar and Linguistics. Husserl and Leśniewski

Qu'en la cort Grammaire a plus d' angles qu'il  
n'a en Logique de jangles  
Quar en toute science est gars mestres qui n'en-  
tent bien ses pars.

from Henri d'Andeli, *La Bataille des Sept  
Ars*.

5.1<sup>113</sup> Husserl's theory of wholes and parts, as we have seen, embodies many insights to be found also in work in contemporary psychology and legal theory. In very few cases however can we talk of a substantial influence of Husserl's theory on the main stream of either psychology or jurisprudence. We have to deal, rather, with shared concerns and tendencies deriving from common roots in 18th and 19th century Austro-German thought. The case is different with respect to logical grammar and linguistics. Husserl's application of the theory of wholes and parts to the problem of independent and dependent meanings in the 4th Investigation decisively influenced Leśniewski's seminal work in the field of what is today called categorial grammar; and it was taken up also by Aj-



dukiewicz and other Polish logicians, whose work has in turn influenced Anglo-Saxon logicians of the last three decades.<sup>114</sup> It is perhaps worth noting however that the theory of mereology, which represents Leśniewski's own attempt to formalise the relationship of part to whole,<sup>115</sup> reveals little influence of the *Logical Investigations*, being essentially a logically sophisticated variant of the Schröderian calculus of domains. It does not however derive from Schröder,<sup>116</sup> but from Leśniewski's own attempts to develop an alternative to the approach to the foundations of mathematics based on classes or propositional functions propounded in Whitehead and Russell's *Principia Mathematica*.

Leśniewski studied philosophy in various German universities before taking his Ph. D. under Twardowski in Lwów in 1912, having developed in particular a deep interest in Marty's philosophy of language. (Leśniewski at one point conceived the project of translating and writing a commentary on Marty's 1902; see Surma, 1977.) He discovered modern symbolic logic through his reading in 1911 of Lukaszewicz's early monograph on the principle of contradiction in Aristotle.<sup>117</sup> According to Leśniewski, Russell's paradox rests on an equivocation in the concept of *class*. We can express his point as follows: we distinguish, in a manner reminiscent of Frege in the latter's review of Schröder, 1890/1905, the *collective* from the *distributive* concept of class.<sup>118</sup> Something is a member of the distributive class of  $\alpha$ 's if and only if it is an  $\alpha$ : thus ' $a$  is a member of the distributive class of  $\alpha$ 's' is, for Leśniewski, just a long-winded way of saying ' $a$  is an  $\alpha$ '. By contrast, a member of the collective class of  $\alpha$ 's need not be an  $\alpha$ . A collective class is what Russell had earlier called a *class-as-one* (Russell, 1903; see also § 1 of the 3rd essay by Simons below), and what Leonard and Goodman were later to call a *fusion*. To take an example used by Leśniewski, the line AB is divided into segments by the points C and D in the diagram below:



In the distributive sense, the segments AD and CB form a class which has neither the whole AB nor the segment CD as members, whereas in the collective sense the class consisting of AD and CB is identical with the whole line AB and also has the segment CD, among others, as member. The collective sense of 'member', then, is simply that of '(proper or

improper) part'. In this sense, as Frege had pointed out earlier, and as Russell held for classes-as-one, there is no question of the existence of such a thing as an empty class. Leśniewski also incidentally rejected the concept of an existing empty class even for the distributive notion of class, as indeed did Russell: the class of  $\alpha$ 's exists, according to Leśniewski, if and only if there is at least one  $\alpha$ .

It is clear now why Leśniewski rejected the formulation of the Russell paradox. According to Leśniewski's collective conception of class, every class is a member (i. e. a part, but not of course a proper part) of itself. Hence no class is not a member of itself. Hence there is no such object as the class of classes which are not members of themselves, by the principle ruling out empty classes, and since Russell's argument depended on the assumption that there is such a class, then, according to Leśniewski, the appearance of paradox vanishes. If, on the other hand, by 'class' is meant the distributive concept, then the only classes which are members of themselves are singletons, i. e.  $a \in a$  is true if and only if there is exactly one  $a$ . So the class of classes which are not members of themselves will not exist unless there are at least two objects, in which case it is identical with the class of all the (two or more) objects there are, and consequently not a member of itself.

It is clear that in adopting a view of classes as concrete entities, Leśniewski is subscribing to a view wholly alien to the later, Frege-Peano concept of a class as an abstract unit. He is here closer in his attitude to that of Schröder or the early Russell. However, Leśniewski admired Frege's formal work more than he admired that of Russell and Whitehead, which he considered sloppy in its use of definitions.<sup>119</sup> He consequently developed his own formal theories to explicate the concept of collective class, and these he used in his analysis of the Russell paradox. The first axiomatic treatment of mereology, initially called by Leśniewski the theory of manifolds, appears in Leśniewski, 1916, where, although the theory is not expressed in a wholly formal way, the treatment is nevertheless rigorous. It is based on the notion of *proper part*, taken (correctly) by Leśniewski as the most intuitive idea of the theory, and contains four axioms, defining on the way the concept of class or complete collection.

This early, slightly inelegant, treatment was replaced later by axiomatic systems based on single notions. Leśniewski himself produced systems based on 'ingredient' (i. e. proper or improper part) and the binary functor '— is outside . . .'; while later workers have produced sys-

tems based, e. g. on '— overlaps . . .' (Lejewski, 1954), or indeed on the monadic predicate '—'s are discrete'.<sup>120</sup>

Although *mereology* was the first formal theory developed by Leśniewski, it is based on principles valid for propositional logic and the logic of noun-expressions, which were developed next. The logic of noun-expressions is called by Leśniewski *ontology*, as it is conceived as a logic of the copula *is*.<sup>121</sup> Ontology in turn presupposes *protothetic*, Leśniewski's propositional logic, which contains variable functors and quantifiers binding both functorial and propositional variables. Thus Leśniewski's logical systems of protothetic, ontology and mereology were developed by him in the reverse order of their order of logical priority.

Each of these formal theories is couched in a language which conforms to rigorous grammatical preconditions on what is formally acceptable. These are stated in the extensive terminological explanations and directives which accompany Leśniewski's presentation of the systems. The expressions of each system have a structure readily and exhaustively describable in the terms of a categorial grammar having as its basic categories *sentence* and *name* (the latter applying only to ontology and mereology, not to protothetic). Derived or functor categories are defined in terms of these, expressions of functor categories being in each case one-sidedly dependent on the corresponding argument expressions.<sup>122</sup>

This grammatical sensitivity on Leśniewski's part was at least to some extent a result of the impression made on him by Husserl's 4th Logical Investigation with its description of the ideal of a pure grammar. Leśniewski's principles were codified in Ajdukiewicz, 1935. Where both Husserl and Leśniewski spoke of meaning or semantic categories, subsequent developments of the same ideas have tended to concentrate on the more tractable issues of syntax.<sup>123</sup>

Because of the differences between the underlying logical syntax of Leśniewski's mereology and of the calculus of individuals of Leonard and Goodman, the two systems are not directly comparable. It is however generally acknowledged that they cover the same subject-matter in much the same way. Both, for instance, are extensional, and both deliberately eschew any commitment to universals, sets or other abstract entities. One difference is that Leśniewski's three theories are very clearly demarcated from each other: the general logic of propositions preceding that of existence and identity, and this in turn preceding the general

theory of whole and part. This clear division is obscured in Leonard and Goodman by their definition of identity in mereological terms.

The Leśniewski system has proved to be a durable object of investigation. It can be interpreted in and is thus consistent relative to protothetic. The fact that it can be approached from many different directions suggests that it has an intuitive solidity shared by systems such as classical and intuitionistic logic and the S 4 modal system. The question remains as to its interpretation, and the extent to which it can be considered *the* logic of part and whole. One problem is that it can be extended in more than one way. *Atomistic* mereology (Sobociński, 1971) assumes that every object contains at least one atom, i. e. an object whose only part is itself, whereas *atomless* mereology asserts that every object has a proper part.<sup>124</sup> Each of these systems can be developed on its own terms, and the atomistic hypothesis is known to be independent of the principles of general mereology. The question as to whether atomistic or atomless mereology represents the world more adequately appears on the face of it to be an empirical one, although it is far from clear as to how it could be empirically resolved.

It could be suggested however that the atomistic hypothesis is one which will have to come up for consideration by any formal theory of part and whole, so this is not a problem peculiar to Leśniewskian mereology. However, it is customary for logicians influenced by Leśniewski's thinking in logic to regard his logical theories as distinguishing themselves from their rivals in being true of the world in which we live. This means that the empirical question is especially pressing. A theory which is purely formal in the sense of Husserl, however, is one for which the question of its adequacy to the world does not as yet arise, for as a purely formal theory its theorems are valid irrespective of how the world should be. Given this attitude to formal logic, it is clear that neither atomistic nor atomless mereology can be a purely formal theory, but must contain an admixture of something empirical. As for the general mereology contained in both the atomistic and atomless variants, it appears to be an open question whether it is a logical theory.<sup>125</sup>

A perhaps more difficult problem concerns the basic logical principles presupposed in Leśniewskian mereology, in particular its extensionalism. For Leśniewski, there cannot be two distinct propositions which could have the same truth value under all circumstances. There are thus, according to this point of view, only four possible functions of a single proposition, namely the four truth-functions. Similarly the the-

ory of existence and identity found in *ontology* has no room for necessity or essentialistic notions, such as are needed to explicate the idea of dependent and independent parts in Husserl's sense. While the laws of extensionality used within Leśniewski's formal systems do greatly facilitate inference, they are not ontologically neutral, since they in effect deny the existence of e. g. distinct but co-extensive properties, or distinct but equivalent propositions or states of affairs. Such an extreme form of extensionalism would today find few supporters. However, the undoubted solidity of the achievements of Leśniewski and his followers suggests that the extensional whole-part theory first elaborated by him is a true theory, even if it turns out to be insufficiently rich for all uses.<sup>126</sup>

5.2 The core of Husserl's argument in the 4th Investigation is that the  -model of n-sided foundation can be applied to grammatical

wholes, and indeed to linguistic wholes in the widest sense, including meanings. This is held to yield, first of all, a precise explication of the distinction between categorematic and syncategorematic linguistic categories, i. e. between those linguistic units (noun-phrases, complete sentences, etc.) which can stand alone as meaningful utterances of various types (see Heinrich, 1910), and those which 'stand in need of completion' by linguistic units of other specific types: which cannot exist in a meaningful utterance except in a more comprehensive unity which connects them with units of those given types. It is held ultimately to yield a system of purely formal distinctions amongst different types of linguistic units according to the types of foundation relation and supplement which they involve. The sentential negation functor *it is not the case that . . .*, for example, becomes recognised as a moment standing in a relation of one-sided dependence upon the category *sentence*; the nominal connective *and* as a moment founded one-sidedly upon the category *pair of names*; the sentential prefix *if* as a second-order moment founded mutually upon a sentential *then*, the compound moment thereby constituted being in its turn one-sidedly dependent upon a pair of sentences; and so on.<sup>127</sup>

Husserl argued that it would be possible, with the aid of mathematics, to develop a purely formal theory of all possible foundation relations amongst all possible categories of linguistic unit.<sup>128</sup> This need not imply that any actually existing language need possess examples of every possible mode of linguistic connection. We can imagine, for example, a lan-

guage in which there are no independently meaningful sub-sentential units (in which all sub-sentential foundation is reciprocal foundation). For such a language there could be no categorial grammar (function-argument grammar) in the usual sense, since the opposition between basic and functor category could not be made. It follows from this however that the criticism of Husserl's idea of a 'pure logical grammar', – a criticism encouraged, perhaps, by the parochiality of the examples Husserl chooses – that it in some sense represents an imposition of Indo-European categories upon other languages,<sup>129</sup> is surely misplaced. Indeed the universal generality of Husserl's pure grammar is shown by the fact that it can be applied even to the diagrammatic languages employed in chemistry, choreography, and elsewhere (as well as to the formal languages of mathematics and mathematical logic).

The distinctions and arguments presented in the 4th Investigation do not by any means exhaust those of Husserl's ideas which are of direct relevance to logical grammar. There is a wealth of material in his hitherto neglected early papers and reviews on logic,<sup>130</sup> in writings collected in the Husserliana edition of the *Philosophie der Arithmetik*, and in the appendix on syntactic forms and stuffs to *Formale und transzendente Logik*.<sup>131</sup> Thus Husserl's early manuscripts<sup>132</sup> contain a startling anticipation of the Tractarian account of the role of operations in logic and arithmetic and of formal concepts (cf. Mulligan, 1980 f.). The distinctions between *Unsinn* and *Widersinn* and between formation rules and laws of transformation are clearly and repeatedly expounded by Husserl in his writings from the *Logical Investigations* onward,<sup>133</sup> and these writings include also an account of modification used by Husserl to explain such phenomena as nominalisation and the use/mention opposition.<sup>134</sup> Whilst Husserl's work on modification and his distinction between syntactic forms and syntactic cores have been ignored by most contemporary logicians, close analogues to these distinctions have played an important role in linguistic accounts of different levels of meaning and linguistic structure, particularly in phonology and syntax.<sup>135</sup>

5.3 Husserl's *Investigations*, including the arguments against psychologism presented in the *Prolegomena to Pure Logic*, had an influence not only in Poland but also in Russia and Bohemia, particularly amongst the members of the Moscow and Prague Linguistic Circles.<sup>136</sup> Thus the first ever translation of a work by Husserl was a translation of the *Prole-*

gomena into Russian which appeared in 1909.<sup>137</sup> Here it is Husserl's influence on Roman Jakobson which is of most importance,<sup>138</sup> particularly as manifested in Jakobson's work on phonology, which he established as a paradigm not only for other branches of linguistics but also for the human sciences in general.<sup>139</sup>

At the centre of Jakobson's many contributions to phonology is on the one hand the idea that phonological systems contain first of all phonemes such as /p/, /b/, /z/, and on the other hand the concept of *distinctive features* (Husserlian moments) such as compact/diffuse, nasal/non-nasal, etc.

The phoneme is neither identical to the sound nor exterior to it, but is necessarily present in the sound, it remains as something which inheres in it and which is imposed on it: it is the invariant in the variations.<sup>140</sup>

We have already seen the notion of an invariant in variations at work in the writings of Husserl and Stumpf. It is employed by Jakobson in his definition of phonemes as that which distinguish words with different meanings in a language.<sup>141</sup> If the replacement of one sound by another in a word or morpheme has no effect on the meaning involved, then the two sounds count only as phonetic variants of a single phoneme.

Phonemes so defined are 'complex unities' of binary distinctive features.<sup>142</sup> /p/, for example, in the English consonantal system, is + Labial, - Voiced, - Nasal. A number of questions have been raised as to whether distinctive features must in every case be *binary* oppositions.<sup>143</sup> More important in the present context however are other claims about distinctive features made by Jakobson which are independent of this issue. The first is the claim that the existence of one distinctive feature necessarily implies the existence of the opposed feature.<sup>144</sup> Jakobson's repeated emphasis on the inseparability, within a linguistic system, of the positive and negative poles of a distinctive feature, amounts to the view that this inseparability cannot be construed in terms of independent properties (pieces) of independent phonemes: each of the terms univocally, reversibly and necessarily calls for its opposite.<sup>145</sup>

His second claim takes the form of an ontological objection to the conception of phonemes as classes of sounds, one of the most influential alternatives to the 'inner' approach to phonology in terms of systems of inseparable moments. Jakobson and Halle, 1956, argue against taking the relation between a phoneme and particular sounds in terms of

class-membership. A phoneme cannot be a family or class of sounds related, say, through an equivalence relation of phonetic resemblance, since this would fly in the face of the fact that when analysing phonetic data we deal directly with invariant properties:

When operating with a phoneme or distinctive feature we are primarily concerned with a constant which is present in the various particulars. If we state that in English the phoneme /k/ occurs before /n/ it is not at all the whole family of its various submembers, but only the bundle of distinctive features common to all of them that appears in this position.<sup>146</sup>

In the same spirit, we can recognise relations of *partial coincidence* between all of the successive members of the following series: distinctive features, phonemes, syllables, morphemes, words, phrases, clauses, sentences, utterances, discourse. Each of these wholes can be seen as a context for the parts that constitute it:

the word is the context of the morphemes, just as the sentence is the verbal context of words . . . while a morpheme in its turn is the context of phonemes.<sup>147</sup>

Philosophers of language have, by and large, not concerned themselves with structural and ontological connections of this sort.<sup>148</sup> They have been tempted, rather, by the possibilities of set-theoretic model-building, i. e. by the construction of analogues of these connections within a set-theoretical framework. Features are conceived as classes and bundles of features are conceived as classes of classes. Once these assumptions are made it is easy to interpret relations of foundation in terms of intersections and Cartesian products of appropriately chosen class-analogues.<sup>149</sup>

In one of his most philosophically interesting papers, "Zur Struktur des Phonems" (1939), Jakobson – in the context of a discussion of the importance of Husserl's work for linguistics – considers the controversial question of the reality of phonemes. He points out that phonology is not required to take up a position on the existence of phonemes but that proponents of, for example, the view that phonemes are fictitious constructs should not overlook the fact that such a view commits them to the fictitious nature of *all* linguistic entities. Similarly a view of phonemes as (abstract) classes, or as classes of classes, etc., commits its defenders to a view of all linguistic entities as abstracta.

Between the elements of a phonological system there are relations of foundation of the types distinguished above. In his 1929 Jakobson



pointed out that laws of foundedness can be reformulated as laws of implication:<sup>150</sup>

if *a* exists then *b* exists too (necessitation),

if *a* exists then *b* is absent (exclusion),

and in principle we can distinguish also, following Holenstein, laws of compatibility:

if *a* exists then *b*, *c*, *d* are possible.

An example of necessitation would be: the acquisition of velar and palatal consonants presupposes acquisition of labials and dentals. Similarly the presence of velopalatals implies the simultaneous existence of labials and dentals. The foundation is not, however, reversible: the presence of labials and dentals does not imply the presence of velopalatals.<sup>151</sup>

Further examples of foundation relations are discussed in Jakobson's "Kindersprache, Aphasie und allgemeine Lautgesetze" (1940/42, §§ 14–17): the acquisition of fricatives presupposes the existence of stops, the existence of one is founded upon the existence of the other.

The laws of one-sided foundation determine the inventory of phonetic systems but also the relative degree of utilisation of particular phonemes in language . . . When both phonemes, the founding as well as the founded, are introduced into child language, the former element generally appears in speech more frequently than the latter.

Jakobson's demonstration that the foundation relations which are to be found in all phonological systems govern the temporal processes of acquisition of linguistic systems by communities of language-users as well as by the individual child, and that they govern the breakdown of such systems in linguistic change and aphasia,<sup>152</sup> provides the most important piece of evidence for the ontological autonomy of phonological systems.

Every phonological system is a stratified structure, that is, forms superposed strata. The hierarchy of these strata is very nearly universal and constant. It appears both in the synchrony and in the diachrony of language; it is, therefore, a panchronic order. If there is a relation of irreversible solidarity [i. e. of one-sided foundation] between two phonological values, the secondary value cannot appear without the first value and the primary value cannot be eliminated without the secondary value. This order shows itself in the existing phonological system and it governs all its mutations; the same order determines, as we have shown,

the learning of language, systems in process of development and – let us add – it persists in language disturbances, systems in the process of breaking up.<sup>153</sup>

Jakobson's seminal analysis of phonemes, their distinctive features and their relations, has been extended by him to syntax, morphology and semantics, and this work has thrown much light on the status of semantic and syntactic features and on their relations of dependence.<sup>154</sup> Holenstein describes Jakobson's analysis of the Russian case-system, for example, as a contribution to eidetic phenomenology which 'shows how single domains of objects can be described by a harmonious system of relational properties'.<sup>155</sup>

The two cases of influence of Husserl described briefly above<sup>156</sup> suggest important substantive questions. To what extent has Husserl's theory, in its application to categorial grammar and to phonology, been modified? Are there good grounds for the modifications and is the potential of Husserl's theory for throwing light on grammar and linguistics yet exhausted?

## § 6 Further Developments: Köhler, Lewin, Rausch

**6.1** The most interesting example of applied whole-part theory outside the field of linguistics is provided by Wolfgang Köhler's *Die physischen Gestalten in Ruhe und im stationären Zustand* (Physical Gestalten at Rest and in the Stationary State) of 1920. Köhler's principal thesis can be stated, somewhat crudely, as follows: that even the most prototypical cases of summative or additive wholes – a heap of resistors, for example, or a line of motor-cycles, or a sprinkling of iron filings – can be converted into wholes that are non-summative by immersion in an electromagnetic field, or by the wiring up of their elements to an electric current.

Köhler's work on physical Gestalten and his recognition of the scientific importance of non-summative wholes were initially sparked by experiments on the behaviour of apes in relation to their environment (op. cit., p. vii). Such experiments had implied that there are states and processes whose characteristic properties and effects are not compounded out of properties and effects of their parts.<sup>157</sup> Such states and processes had, since Ehrenfels' classic paper "Über Gestaltqualitäten" of 1890, come to be called 'Gestalten'. The two criteria for Gestalthood formulated by Ehrenfels were as follows:

- A psychological whole (complex content) exhibits Gestalt structure only if

I. the  $n$  constituent stimuli (e. g. the  $n$  notes of a melody) are such that when experienced in order by a single subject then the total stimulus is greater than the sum of the separate stimuli as these would be experienced by  $n$  separate subjects; (the difference between the two is, in Ehrenfels' terms, the specific Gestalt-quality of the complex); and

II. this specific property is such that it remains unchanged when the complex of stimuli on which it rests suffers certain determinate kinds of displacement (e. g. the transposition of the melody into a different key).<sup>158</sup>

Criterion I is satisfied, Köhler argues, only if the constituents of the complex satisfy the condition which he calls *functional proximity* (absent when, for example, the notes of a melody are sounded at one month intervals; cf. 1920, p. 35).<sup>159</sup> Further, both criteria apply just as well to continuous manifolds as to the finite wholes of discreta considered by Ehrenfels. Substituting the more general criterion of functional proximity for Ehrenfels' criterion I, it can then be claimed that not only psychological complexes but also certain physical wholes exhibit Gestalt structure in the modified sense. The two resultant criteria are satisfied, for example, by electrostatic structures, invariant with respect to transpositions of the material make-up of the conductor (which can be made of lead, of silver, etc.), of the spatial position and dimensions (though not the form) of the conductor, and with respect to variation in the total charge. Similarly, the electromotive force at the boundary between two electrolytes is invariant, given constant relative difference, with respect to changes in absolute concentration.<sup>160</sup>

Köhler put forward the hypothesis that, physics being a much further advanced discipline than psychology, it would be possible to clarify psychological Gestalten by investigating their physical analogues. The hypothesis gains additional strength from the fact that the central nervous system itself, and each specific stimulus field within the human organism, can be conceived as a physical Gestalt-structure, nerve reactions as Köhler conceived them being in some respects analogous to electrochemical reactions in weak, partially ionised solutions (1920, p. 5 f.).<sup>161</sup>

Köhler's own definition of 'summativity' was as follows:

A collection (*Zusammen*) is a pure sum of parts or pieces [is a purely summative whole] if and only if it can be assembled from its parts one after the other without

any of the parts suffering any alteration as a consequence of the process of assembly (op. cit., p. 42).<sup>162</sup>

He conceives this definition as equivalent to the following:

A collection is a pure sum if and only if, through separation of parts or pieces, neither the residue partial collection . . . nor the part that has been separated should suffer any alteration (loc. cit.).

These definitions are, as we shall see in 6.3 below, too crude to demarcate a single homogeneous category of cases. Not only is their equivalence highly questionable, but they are too crude also in virtue of the fact that a given whole may exhibit summativity in respect to certain properties, but Gestalt-structure<sup>163</sup> in respect to others. Three electrostatically charged conductors in proximity to each other, for example, constitute a pure sum from the point of view of weight, but not from the point of view of distribution of charge: differences in electrostatic potential across a system are not reducible to electrostatic properties of the parts of the system.

Examples of absolutely summative wholes are difficult to come by. Even a heap of stones fails to satisfy the definition in an absolute sense, in virtue of the gravitational relations between the individual stones and the earth, as a result of which any relative motion of the stones will normally cause (at least) changes in position of the residue of the heap. We can however agree that

with certain exceptions those objects readily designated as 'things'<sup>164</sup> constitute purely summative wholes with one another so long as they do not come into contact . . . or, if they do come into contact, so long as the contact is weak and lies perpendicular to the direction of the earth's gravity (op. cit., p. 48).

If, in contrast, we look at the charge-structure of a conductor: any change in the physical form, any partitioning of the conductor, any alteration or removal of charge at any point, of necessity brings about a change in the charge-structure of the whole. It is as if the parts of the conductor interpenetrate reciprocally; they do not exist merely side by side with each other, as is the case in a purely summative whole.

In attempting to develop a logic of non-summative wholes Köhler introduces the concept of an *Eigenstruktur* (inherent or intrinsic structure), i. e. of that kind of spontaneous order which affects given physical

materials in reflection of certain types of surrounding conditions. An *Eigenstruktur* is not decomposable into pieces (it is not the *sum* of any constituent microstructures). It is however possible to distinguish abstractly within it *moments* of the structure: the *charge at a given point* in a complex conductor is a moment of the total charge structure.<sup>165</sup> This implies that it is impossible to create an *Eigenstruktur* by injecting an appropriate charge at every point: the moments of the structure *verhalten sich gegenseitig nicht wie 'Dinge'* (cf. op. cit., p. 66).

Gestalten as conceived by Ehrenfels are produced by mental activity on the basis of discrete, pre-existent contents, merely externally related to each other and in themselves undergoing no change as a result of becoming combined into complexes. Physical Gestalten are not produced in this sense. And, Köhler argued, even with regard to mental formations it is not the case that they are built up out of elementary sensations: we cannot explain perception as a summation of externally related micro-stimuli. To account adequately for either physical or psychological phenomena a more general theory of part-whole relations is required. It has been argued above that such a theory was outlined by Husserl in the 3rd Logical Investigation; hence it will be interesting to examine Köhler's reactions to Husserl's views. We have already pointed out that Husserl borrowed from Meinong the terminology of foundation in advancing his theory of part and whole. Meinong had merely substituted for Ehrenfels' 'Gestalt' the term 'founded content', accepting Ehrenfels' underlying theory with only minor hesitations (see Meinong, 1891 and 1899 and compare Ehrenfels, 1937). Unfortunately Köhler, in his discussion of Husserl's work, assumes that Husserlian foundation is to be understood exactly as in the Ehrenfels-Meinong theory.

Consider, once again, a system  $\Sigma$  of conductors, *a*, *b*, *c*, in an electrostatic field. Köhler argues that *a*, *b* and *c* are not dependent parts of the system in Husserl's sense (see § 3 above), since each might well occur in isolation from the others (p. 32 f.). This is to ignore Husserl's distinction between *a qua* constituent of  $\Sigma$  (or *a qua* bearer of the given charge) and *a qua* consignment of conductive material, the former a moment, the latter a mere piece of the system  $\Sigma$ . That is, it is to ignore Husserl's thesis to the effect that foundation relations hold between individuals only in reflection of the essential structures of those individuals.

Köhler also criticises Husserl for ignoring the question as to how and under what conditions entities come together to form a whole (p. 58). For Köhler, what is interesting is precisely the real, physical possibility

of an object's remaining in existence whilst at the same time suffering a determinate and spontaneous transformation of its intrinsic properties: "Husserl, as far as I can see, asks to what extent pieces somehow placed in relation to each other as if they were things can allow a whole to arise above them" (loc. cit.).

Such remarks reveal that Köhler, again through confusion with Meinong's specifically psychological concept of foundation, misunderstood the purely formal nature of Husserl's work. This was to a certain extent encouraged by Husserl's continued use of the psychological terminology of 'contents' and by his lack of consideration of non-psychological examples of foundation relations. The deficit is made up, to some extent, by vol. III of Ingarden's *Der Streit um die Existenz der Welt* (1974).<sup>166</sup>

Köhler contrasts his own ontological views with *absolute holism*, on the one hand, and *atomism*, on the other (pp. 153 ff.).<sup>167</sup> According to the position of absolute holism, nature contains no independent parts; all states and processes are real only in the nexus of the world as a whole, all parts are products of abstraction. This view, which Köhler castigates as a form of romanticism, implies the impossibility of natural science. The atomist position, in contrast, regards nature as built up out of *Und-Verbindungen* (mere sums) of independent parts.<sup>168</sup> Köhler takes a position according to which holism is of only limited or local validity. It is, he claims, the fundamental experience of all experimenters, that – in contrast to the absolute holist view – leaving aside the interdependencies to be found within finite neighbourhoods of certain determinate types, the interconnections between physical processes in different regions of the world are relatively trivial (p. 156). Unfortunately the unacceptability of absolute holism, combined with the fact that the overwhelming bulk of the furniture of the world of ordinary everyday experience exhibits relations of a merely additive character, has led to the acceptance of atomistic or micro-reductivist research programmes in all developed sciences<sup>169</sup> at the expense of a lack of understanding of those types of structures crucial to the understanding of the phenomena of psychology.

6.2 The second development of the theory of part and whole considered here was made by another student of Stumpf, the psychologist Kurt Lewin in his book *Der Begriff der Genese in Physik, Biologie und Entwicklungsgeschichte. Eine Untersuchung zur vergleichenden Wissen-*

*schaftslehre* (The Concept of Genesis in Physics, Biology and Evolutionary History. An Investigation in Comparative Theory of Science).<sup>170</sup> We tend to conceive a physical object such as a stone as the same object from moment to moment. Lewin however sees temporally extended objects as multiplicities of successive entities. Consider, for example, a perfectly isolated bell-jar in which chemical reactions are taking place across a temporal interval  $(t_1, t_2)$ . Define  $G_{t_i}$  as the totality of simple or complex chemical formations existing in the bell-jar at  $t_i$ . Then  $G_{t_2}$  stands to  $G_{t_1}$  in the relation of existential being-such-as-to-have-come-forth-from (*existentiellen Auseinanderhervorgegangenseins*) to  $G_{t_1}$ , a relation which is independent of the specific properties of the constituents of the  $G_{t_i}$ . It is this same relation of existential antecedency that one has in mind when one considers e. g. the phenomenon of expansion of a metal in physics. It was Lewin who introduced the term 'genidentity' to designate the given relation. However, the concept of genidentity that is relevant to physical formations is, as we shall see, distinct from that which is relevant to biology: the transition from one discipline to another implies a corresponding change in the manner of dividing up reality into units. Hence we shall find it necessary to distinguish a number of distinct (though interrelated) concepts of existential being-such-as-to-have-come-forth-from.

It is necessary, first of all, to distinguish simple from complete genidentity. An amputated limb is simply genidentical with the whole body from which it had been amputated. The relation of complete genidentity, in contrast, holds only between the whole body on the one hand, and the totality consisting of mutilated body, limb and residue, on the other. Complete genidentity is thus simply an expression of the physicist's attempt to isolate his experiments from extraneous disturbances.

The concept of complete (physical) genidentity is required if we are to formulate, for example, the law of conservation of mass. This should properly read (cf. Lewin, op. cit., p. 12):

if two or more physical formations are completely genidentical with each other, then they are of identical mass.

This law expresses a relation among objects. The law of conservation of energy expresses a relation not among objects, but among events, which also exhibit relations of genidentity (for example between a dying and a death).<sup>171</sup>

Simple (physical) genidentity may be symbolised by means of ' $\equiv$ '; complete (physical) genidentity by ' $\equiv$ '; absolute identity by ' $\equiv$ '. Writing ' $\leq$ ' for 'is a proper or improper part of' and '/' for 'is discrete from'<sup>172</sup>, ' $\equiv$ ' can be defined in terms of ' $\equiv$ ' as follows:

$$a^p \equiv b := \neg \exists x (x/a \ \& \ x^p = b) \ \& \ \neg \exists x (x/b \ \& \ x^p = a)$$

(cf. Lewin, op. cit., p. 27). Then clearly:

$$a^p \equiv b \rightarrow \forall x (x/b \rightarrow a^p \neq x)$$

$$a^p \equiv b \rightarrow \forall x (x/a \rightarrow b^p \neq x)$$

$$a^p = b \rightarrow \exists a' \exists b' (a' \leq a \ \& \ b' \leq b \ \& \ a'^p \equiv b')$$

Thus if a piece of metal falls into an acid, then we know that this substance must be present in some form in the liquid, even though it may have entered into chemical combination with it (op. cit., p. 29).

If we define  $t(x)$  as the temporal position of the object  $x$ , then we may formulate the following principle of temporal density of genidentity:

$$a^p \equiv b \rightarrow \exists x (t(a) < t(x) < t(b) \ \& \ a^p \equiv x \ \& \ x^p \equiv b)$$

(and similarly for ' $\equiv$ ').

We may also formulate principles of continuity:

$$a^p \equiv b \rightarrow \forall t (t(a) < t < t(b) \rightarrow \exists c (t(c) = t \ \& \ a^p \equiv c \ \& \ c^p \equiv b))$$

and of transitivity:

$$(a^p \equiv b \ \& \ b^p \equiv c) \rightarrow a^p \equiv c$$

(this principle does not hold for ' $\equiv$ ').

Sequences of physical formations exhibiting complete genidentity extend indefinitely, both into the past and into the future:

$$\forall a \exists b \exists c (a^p \equiv b^p \equiv c \ \& \ t(b) < t(a) < t(c)).$$

Further, such sequences possess no singularity points. Every arbitrary section through a sequence of genidentical formations unequivocally determines the whole sequence in both directions.

In Lewin's view, physical formations may be demarcated into parts and wholes at will. "Every real part of a physical formation and every



complex of physical formations can be considered in its turn, insofar as genidentity relations come into question, as a physical formation in its own right" (p. 39). We can now assert the following principles concerning the decomposition of physical complexes into their constituents (e. g. into constituent molecules):

$$(a \equiv [a_1, a_2, \dots, a_n] \& a^p \equiv b) \rightarrow \exists_{i=1}^n b_i \{ b \equiv [b_1, b_2, \dots, b_n] \& \forall j (b_i / b_j \rightarrow i \neq j) \& a_1^p \equiv b_1 \& \dots \& a_n^p \equiv b_n \};^{173}$$

$$(a \equiv [a_1, a_2, \dots, a_n] \& b \equiv [b_1, b_2, \dots, b_n] \& a_1^p \equiv b_1 \& \dots \& a_n^p \equiv b_n) \rightarrow a^p \equiv b.$$

Biological genidentity relations hold wherever roots, sprouts, eggs, embryos, develop into something which they are not.

Embryology, evolutionary theory, in short the whole of biology insofar as it is concerned with phylogenetic or ontogenetic processes of development, whether of a morphological or a physiological kind, consists above all in the investigation of biological formations which stand in relations of existential being-such-as-to-have-come-forth-from (p. 53).

Sequences of biologically genidentical formations are to be distinguished from physical genidentity sequences:

The physical genidentity sequences flowing forwards from an egg lead to the widest variety of possible formations, and if any kind of physical genidentity relation obtains between the egg and the hen, then there belongs to the adult hen at most formations which are physically genidentical with a fraction of the egg (p. 56).

Lewin distinguishes two relations of biological genidentity, the relation of genidentity between successive sections of a single individual, (discussed below) and the relation of (simple and complete) genidentity between an individual and his descendents, whether this obtains between metazoa, protozoa, animals, plants, between complete organisms or individual cells, whether through vegetative or sexual reproduction, through sprouting or division. He calls the relation between an individual and his descendents (or, more generally, between successive members of different generations) *Avalgenidentität*.

If we write ' $a^a = b$ ' for ' $a$  stands to  $b$  in the relation of descendent to

forbear', then typically we have to face systems of (simple) avalgenidentity relations such as the following.<sup>174</sup>

$$\begin{array}{ccc}
 a_{n-1} & a \equiv & a_{n+1} \\
 a'_{n-1} & a \equiv & a_n & a \equiv & a'_{n+1} \\
 a''_{n-1} & a \equiv & a & a \equiv & a''_{n+1}
 \end{array}$$

Complete avalgenidentity, symbolised by  $a \equiv$ , gives rise to systems such as the following:

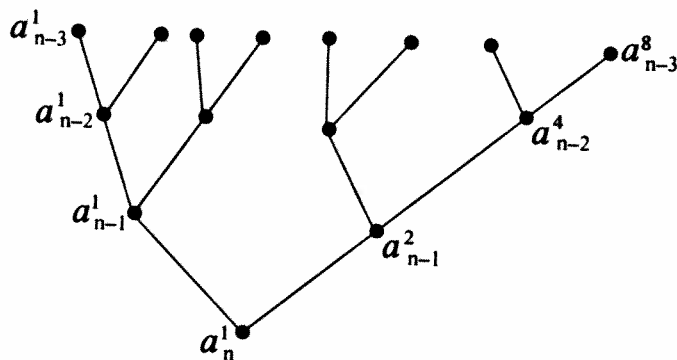

where  $a_n^1 \equiv [a_{n-1}^1, a_{n-1}^2] \equiv [a_{n-2}^1, a_{n-2}^2, a_{n-2}^3, a_{n-2}^4]$ , etc.

Writing  $S_{-i}^k$  for  $[a_{n-i}^1, \dots, a_{n-i}^k]$ , then we may symbolise the avalgenidentities between successive sections through an avalsequence by:

$$S_0^1 \equiv S_{-1}^2 \equiv S_{-2}^4, \text{ etc.}$$

Further, we have

$$\begin{array}{l}
 S_i^a \equiv S_j \rightarrow \forall a_i \in S_i (a_i^a = S_j) \\
 a_i^a = b_0 \rightarrow \exists x_i y_i \dots [a_i, x_i, y_i, \dots] \equiv b_0
 \end{array}$$

A single biological formation may occur more than once as element of a single section through an avalsequence. And avalsequences may intersect: a section may belong to distinct complete avalsequences, although

it may occur as the 0-sequence in only one avalsequence (op. cit., pp. 90–94). Elements of the same generation in an avalsequence may be wholly non-contemporaneous; contemporaneous biological formations may belong to distinct generations. In contrast to the physical case, the elements of an avalsequence are not temporally punctual entities, but entities exhibiting their own individual temporal development.

Lewin also considers the relation of genidentity between successive temporal sections through biological individuals (including not only complete organisms, but also individual organs, cells, etc.). Writing ' $a^i = b$ ' for ' $a$  is simply individual-genidentical to  $b$ ' (as, for example, an ameoba is simply individual-genidentical to either half of itself after splitting), and ' $a^i \equiv b$ ' for ' $a$  is completely individual-genidentical to  $b$ ', we have:

$$a^i = b \rightarrow \exists xy \dots x'y' \dots ([a, x, y, \dots]^i \equiv [b, x', y', \dots]).$$

Individual-genidentity is a transitive relation. It is characterised, like physical and avalgenidentity, by continuity, but also by the existence of a youngest section (having no individual-genidentical predecessors) and an oldest section (*der Todesschnitt*, having no individual-genidentical successors).<sup>175</sup>

**6.3** In our discussion of the Gestalt-psychological concept of summative whole in § 6.1 above, we pointed out that the definition given by Köhler in his *Die physischen Gestalten in Ruhe und im stationären Zustand* (p. 42, cf. p. 67 above) did not succeed in demarcating a single formal ontological concept. The task of reconstructing Köhler's definition was undertaken by his student, Edwin Rausch, in his work "Über Summativität und Nichtsummativität" (On Summativity and Non-Summativity) of 1937. This work is of interest since, building upon a close familiarity with the range of physical and psychological examples investigated by Köhler and his associates, Rausch formulates a taxonomy of the corresponding types of wholes and parts whose generality rests essentially on exploitation of the flexibility of modern symbolic logic (and specifically in its capacity to represent *multiple generality*).

Rausch takes as his starting point the concept of a finite, spatially extended, static *manifold* or *collective* (*Zusammen*), *Z*, a concept interpreted broadly enough to include not only collective wholes occurring in objective physical space, but also spatial manifolds occurring in the

phenomenal fields of conscious subjects. The constituents of a collective  $Z$  may therefore be either physical things or perceptual contents arising, e. g., in the observation of spatial signs.<sup>176</sup>

A *partition* (*Einteilung*),  $E$ , of  $Z$  is a purely conceptual division of  $Z$ , and of the space (or phenomenal field) surrounding  $Z$ , into a finite number  $n$  of discrete, more or less arbitrarily demarcated parts,  $t_i (Z^E)$ ,  $i = 1, 2, 3, \dots, n$ , which exhaust the totality of  $Z$ .<sup>177</sup> It is as if  $E$  imposes upon  $Z$  (and upon the surrounding space), according to its dimensionality, a 1-, 2- or 3-dimensional *grid*. A line of  $n$  motorcycles, for example, has a *natural partition* into its constituent vehicles, but it may also be partitioned into e. g.  $2n$  wheels plus a single residual constituent.<sup>178</sup>

Given a manifold  $Z$  and a partition  $E$  we may consider properties of the resultant partitioned manifold  $Z^E$  and of its parts  $t_i (Z^E)$ ,  $i = 1, \dots, n$ , either from the point of view of conceptually possible *removal* of parts, or from the point of view of conceptually possible processes of *assembly*. Köhler, as we saw, held these two modes of consideration to be such as to lead to equivalent definitions of summativity (see p. 67 above). It may indeed be the case that the respective definitions are extensionally equivalent, – or that they are extensionally equivalent over all example-domains familiar to workers within existing scientific disciplines. Rausch, however, argues that in the absence of more detailed analyses it would be illegitimate to presuppose that they are logically equivalent.

Consider, first of all, the concept of *invariance* of an arbitrary part  $t_i (Z^E)$  under removal or subtraction from the collective  $Z$ . We shall employ ' $\Phi(t_i)$ ' to designate the physical removal, by some specific process (e. g. pruning of a leaf, unscrewing of a bolt, etc.), of  $t_i$  from  $Z$ .

$$t_i (Z^E) \text{inv} \Phi(t_i)$$

will express the proposition that  $t_i$  is invariant under removal from  $Z^E$  by process  $\Phi$ . The first concept of summativity distinguished by Rausch is then defined as follows (Rausch, p. 216):

$$S_{\text{inv}}^{\Phi}(Z^E) := \forall i (t_i (Z^E) \text{inv} \Phi(t_i)).$$

Clearly Köhler's collection of spatially disparate stones fulfils this definition under the natural partition, where ' $\Phi$ ' signifies simple physical removal.

A second concept of summativity is obtained if we consider not the invariance of an arbitrary part upon removal, but rather the invariance of the *residue*:

$$S_{\text{inv}}^{\Phi}(Z^E): = \forall i ((Z^E - t_i) \text{inv} \Phi(t_i)).^{179}$$

We can also impose the condition of invariance, under removal of an arbitrary part, not of the residue-manifold taken as a whole, but of any arbitrary part of the residue-manifold:

$$S_{\text{inv}}^{\Phi''}(Z^E): = \forall i \forall j (t_j (Z^E - t_i) \text{inv} \Phi(t_j)),$$

or the weaker condition of invariance of at least one part of the residue-manifold:

$$\forall i \exists j (t_j (Z^E - t_i) \text{inv} \Phi(t_j)).$$

A process  $\Phi$  of removal or separation may be associated with a converse operation  $\bar{\Phi}$  of *addition* of parts. An initial approximation to the first of Köhler's two definitions of summativity might then be:

$$S_K^{\bar{\Phi}}(Z^E): = \forall i (t_i (Z^E) \text{inv} \bar{\Phi}(t_i))$$

where  $t_i (Z^E) \text{inv} \bar{\Phi}(t_i)$  is to signify that  $t_i$  remains invariant under addition to  $Z^E - t_i$ .

We can define the following variant concepts:

$$S_K^{\bar{\Phi}}(Z^E): = \forall i ((Z^E - t_i) \text{inv} \bar{\Phi}(t_i))$$

i. e. each sub-manifold  $Z^E - t_i$  remains invariant under augmentation by the corresponding  $t_i$ ; an  $n$ -fold whole is summative in this sense iff every  $(n - 1)$ -fold sub-whole is invariant under augmentation;

$$S_K^{\bar{\Phi}''}(Z^E): = \forall i \forall j (t_j (Z^E - t_i) \text{inv} \bar{\Phi}(t_j));$$

$$S_K^{\bar{\Phi}'}(Z^E): = \forall i \exists j (t_j (Z^E - t_i) \text{inv} \bar{\Phi}(t_j)).$$

A more adequate approximation to Köhler's two definitions is achieved however if we consider invariance not merely under separation or addition of single members, but rather invariance under complete or total de-

composition (or construction) of the whole  $Z$ . An  $n$ -manifold  $Z^E$  exhibits  $n! \sum_{i=1}^{n-1} \frac{1}{i!}$  in principle possible piece-wise decompositions (Rausch, pp. 233–30). Clearly there may be types of collectives in which the order of decomposition plays no role, others in which certain orders of decomposition have distinct effects, or are physically impossible. Summativity will be associated with collectives belonging to the first of these groups.

If we imagine the tree of possible decompositions of the  $n$ -manifold  $Z^E$ , any given  $t_i$  will be contained in  $2^{n-1} - 1$  of the (proper and improper) sub-manifolds which form the nodes of the tree. Introducing the expression ' $M_{ik}(Z^E)$ ' to designate the  $k$ th respective  $t_i$ -containing sub-manifold of  $Z^E$  under some lexicographical ordering,  $k = 1, 2, 3, \dots, 2^{n-1} - 1$ , (Rausch, p. 230f), we can define the following strengthened form of Köhler-summativity:

$$S_{KK}^{\Phi}(Z^E) := \forall i \forall k (t_i(M_{ik}(Z^E)) \text{inv} \Phi(t_i)),^{180}$$

with the variants:

$$S_{KK}^{\Phi'}(Z^E) := \forall i \forall k ((M_{ik} - t_i) \text{inv} \Phi(t_i)),$$

etc. (see Rausch, pp. 235–37).<sup>181</sup>

Köhler's original definitions refer merely to 'assembly' and to 'separation'. Thus they pay no regard to the possibility that variance and invariance properties may be dependent upon the manner in which parts are joined or removed (suddenly or gradually, violently or cautiously; 'with a hammer, with a screwdriver', etc.). We can take into consideration the range of possible processes of addition/subtraction by treating ' $\Phi$ ' as a variable expression, thereby obtaining the following amended version of  $S_{inv}^{\Phi}$ :

$$S_{inv}(Z^E) := \forall i \forall \Phi (t_i(Z^E) \text{inv} \Phi(t_i)),$$

and the much weaker condition:

$$S_{inv}^{\circ}(Z^E) := \exists \Phi \forall i (t_i(Z^E) \text{inv} \Phi(t_i)),$$

and correlately for each of the definitions  $S_{inv}^{\Phi}$ , etc.

Köhler's definitions refer further merely to 'invariance of parts'. It may however be fruitful to consider invariance not of parts, but of *properties* of parts: a banana is invariant under removal from a bunch in regard to its weight, not e. g. in regard to its spatial position. Introducing ' $e(t_i)$ ' as a variable functional expression ranging over properties of  $t_i$ , we may generate a further sequence of summativity concepts as follows:

$$S_{\text{inv}}^{\Phi^*}(Z^E) := \forall i \forall e (e(t_i) \text{inv}\Phi(t_i))$$

and

$$S_{\text{inv}}^{\Phi^{**}}(Z^E) := \exists e \forall i (e(t_i) \text{inv}\Phi(t_i)),$$

etc.

In relation to  $S_{\text{inv}}^{\Phi^{**}}$  (and certain variants) it is possible to define a concept of summativity for properties: a property  $e$  is said to be  $S_{\text{inv}}^{\Phi^{**}}$ -summative relative to  $Z$  and  $E$  iff it satisfies

$$\forall i (e(t_i(Z^E)) \text{inv}\Phi(t_i))$$

(Rausch, p. 267).  $e$  is absolutely  $S_{\text{inv}}^{\Phi^{**}}$ -summative iff it satisfies

$$\forall Z \forall E \forall i (e(t_i(Z^E)) \text{inv}\Phi(t_i)).$$

Similarly we can define concepts of summativity-with-regard-to-property- $e$  (e. g. mass, colour, etc.) by, e. g.

$$S_{\text{inv}}^{\Phi^e}(Z^E) := \forall i (e(t_i(Z^E)) \text{inv}\Phi(t_i)).$$

The summativity concepts defined so far all relate to manifolds subject to arbitrarily determined partitions  $E$ , conceived as imposed by the experimenter. If we wish to define a concept of *ontological summativity*, a concept which would involve no relativisation to any arbitrarily imposed partition, i. e. which would relate directly to the underlying manifold itself, then this can be achieved by treating the hitherto constant term ' $E$ ' as a variable, and quantifying over partitions of  $Z$  as follows:

$$S_{\text{ont}}^X := \forall E (S^X(Z^E))$$

where  $X$  ranges over the various S-indices introduced above.

A further sequence of ontological summativity concepts is obtained by means of the schema:

$$S_{\text{ont}}^{X^0} := \exists E(S^X(Z^E)).$$

Besides subtraction  $\Phi$ , and addition  $\bar{\Phi}$ , of parts, we can consider also other operations on a collective. In particular we can consider various types of *variation*  $\psi$  (of the parts of a physical whole or of a psychological content).<sup>182</sup> Thus for example

$$S_{\text{inv}}^{\psi}(Z^E) := \forall i((Z^E - t_i)\text{inv}\psi(t_i))$$

signifies that  $Z^E$  is such that each  $Z^E - t_i$  is invariant under the process of  $\psi$ -variation (e. g. increase in size, or intensity of electric charge) of  $t_i$ .<sup>183</sup>

Rausch considers the following condition of non-summativity relative to  $\psi$ -variation:

$$N^{\psi}(Z^E) := \exists e \exists e' \forall i(e(t_i(Z^E))\text{var}\psi(e'(t_i)))$$

i. e. that, for a given manifold and partition, there should exist a pair of properties,  $e$  and  $e'$  which are such that, for each member  $t_i$  of  $Z$ ,  $\psi$ -variation of the first property brings about a consequent variation of the second property. It would be fruitful to investigate the relationship between this condition and the condition of one-sided dependence of properties considered by Stumpf and Husserl.

$e$  can be said to be dependent in  $Z$  upon  $e'$  if

$$\forall E \forall i(e(t_i(Z^E))\text{var}\psi(e'(t_i)));$$

and  $e$  is absolutely dependent upon  $e'$  if

$$\forall Z \forall E \forall i(e(t_i(Z^E))\text{var}\psi(e'(t_i))).$$

Thus consider a system  $L$  of  $n$  conductors  $L_i$ , connected together by wire whose capacity is negligible in relation to that of the  $L_i$  and placed so far apart that they do not influence each other through field effects. Writing ' $c(L_i)$ ' for 'the capacity of  $L_i$  in  $L$ ' and ' $q(L_i)$ ' for 'the quantity of charge in  $L_i$ ', then the state of equilibrium of the system is given by



$$q(L_i) = q(L) \frac{c(L_i)}{\sum_{j=1}^n c(L_j)}$$

The condition  $N^\psi$  given above is satisfied by the system  $L$  under the natural partition defined by  $t_i = L_i$ , where  $e = c$ , and  $e' = q$ . That is:

$$\forall i (q(L_i(L)) \text{var}\psi(c(L_i))),$$

where 'ψ' signifies a specific variation of capacity (cf. Rausch, p. 275f). Similarly we have:

$$\forall i \forall j (q(L_j(L - L_i)) \text{var}\psi(c(L_i)))$$

i. e. a change in the capacity of an arbitrary conductor brings about an adjustment in the charge of all remaining conductors: the charge of a conductor depends not only on its own capacity (on the local conditions), but on the capacities of all the remaining conductors in the system.

The above is a treatment of only a selection of the summativity and non-summativity concepts distinguished by Rausch. They are of relevance not only in the areas of physics and perceptual psychology but also, in principle, to wholes of every kind. Thus we can make a distinction between two kinds of summativity according to the *order* in which the elements of a whole may be separated from it (see n. 180 above), and such a distinction between kinds of wholes can be seen at work in, for example linguistics, in the familiar distinction between restrictive or defining and non-restrictive or non-defining relative clauses. This distinction might be illustrated by respectively:

*the man in the corner who is looking at his hands is a philosopher*

and: *the man in the corner, who is looking at his hands, is a philosopher.*

Or: *knowledge which comes from books is power*

and: *knowledge, which comes from books, is power.*

The non-italicised portion of the second example is in each case detachable without loss of meaning. This is not the case in regard to the

corresponding portion of the first example: here the italicised portion must be separated from the sentence as a whole.

6.4 We should like, by way of an appendix, to consider briefly a number of notational issues raised by the Stumpf-Husserl theory of wholes and parts.<sup>184</sup> The dependence diagram,

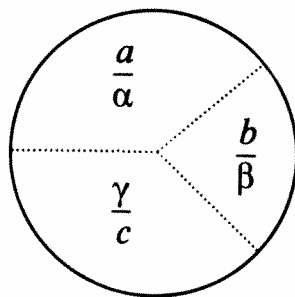

as already noted at n. 72 above, is ambiguous; it may signify either the obtaining of three distinct relations of pairwise mutual dependence, of *a* on *b*, *b* on *c*, and *a* on *c*, or the inherence in *a*, *b* and *c* of a single relation of three-fold mutual dependence. That this distinction is not an empty one is seen by considering the case of a polymorphously polygamous tribe which allows marriage both between pairs and between triples of individuals. If a single 3-marriage bond holds between *a*, *b* and *c*, then divorce between *a* and *b* can be effected only at some cost to *c*, which is not the case where *a*, *b* and *c* are respectively 2-married to each other.<sup>185</sup>

Three-fold reciprocal dependence may be unambiguously represented by means of a diagram such as the following:

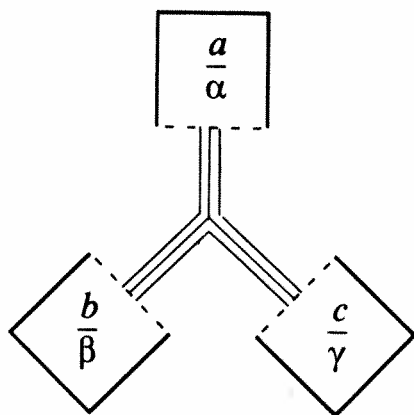

(and similarly for 2-, 4- and n-fold reciprocal dependence). The complex of relations of pair-wise dependence may then be symbolised by:

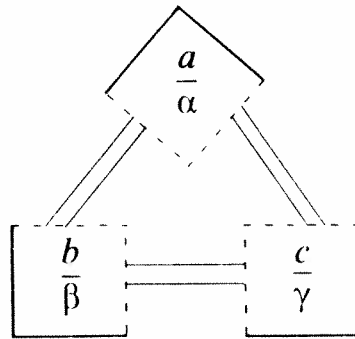

Mutual dependence relations (whether 2- or n-fold) are in each case represented by multiple lines. One-sided dependence may be represented by means of single lines:

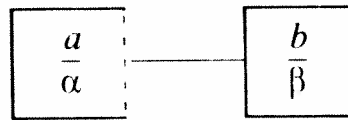

where independence of an object or content is symbolised by solid walls.

The above diagram may represent, say, the inherece of a specific moment of redness  $a$  in a beetroot,  $b$ . It is as if  $a$  and  $b$  lay behind the page, capable of being viewed as articulated in some specific way by the windows which make up the figure. This articulation may be more or less crude.

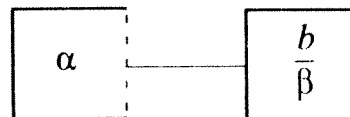

for example, might symbolise 'the tomato  $b$  is red';

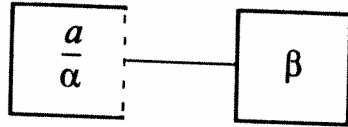

'the individual redness-accident  $a$  inheres in a tomato';

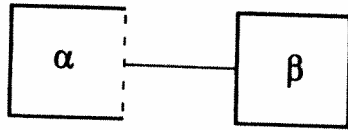

'a tomato is red';

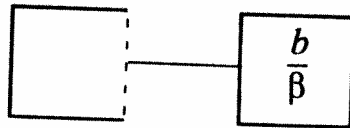

'something inheres in the tomato  $b$ ';

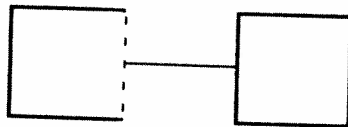

'something inheres in something';

and finally perhaps also

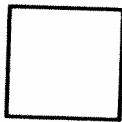

'something (some independent whole) exists'.

Such devices, which go some way to rendering superfluous the quantifier machinery of modern predicate logic and at the same time to restor-

ing the common noun to philosophical respectability,<sup>186</sup> have been thoroughly explored by Wolfgang Degen in unpublished writings.<sup>187</sup>

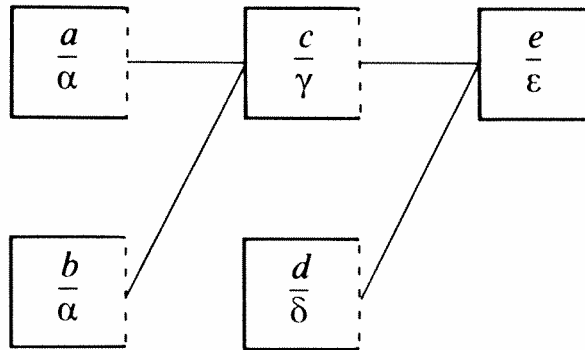

might signify the dependence of two successive bouts of fever, *a* and *b*, on the disease *c*, inhering, along with the knighthood, *d*, in the individual *e*.

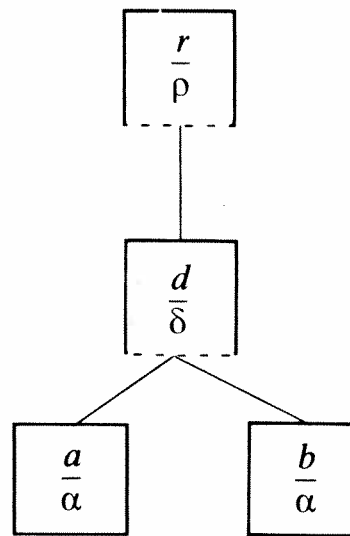

might signify the dependence of the reconciliation *r* upon the disagreement *d*, which is in turn a two-place temporally extended moment inhering in the pair of individuals *a*, *b*.<sup>188</sup>

The analogy of the window introduced above is not an arbitrary one. Dependence diagrams are *pictures* of states of affairs, and may be taken as propositional signs in the sense of the *Tractatus*.<sup>189</sup> The directly depicting language thereby determined reveals a hitherto unnoticed point of contact between Wittgenstein's early logical work and the primitive

experiments of Euler and Venn on a two-dimensional logical notation.<sup>190</sup>

The parts of an existing state of affairs also exist.<sup>191</sup> Hence a directly depicting language must satisfy the condition that *every well-formed constituent of a propositional sign  $\Gamma$  admits of being inferred as a consequence of  $\Gamma$* . Degen has pointed out that a language which satisfies this requirement allows the perspicuous representation of certain forms of inference (which he calls *grammatical* as opposed to *logical* inference) in a fashion which avoids the highly unnatural detour through quantification theory imposed by predicate logic. Thus consider the sentences:

- (a) Hans kisses Erna three times.
- (b) Hans kisses someone three times.
- (c) Hans kisses Erna.
- (d) Someone kisses Erna.
- (e) Hans kisses three times.
- (f) Erna is kissed.
- (g) There is kissing.

Part of what is involved in the mastery of the grammar of a language such as English is the ability to recognise immediately the inferential relations between sentences of this kind, relations which may, in this case, be represented as follows:

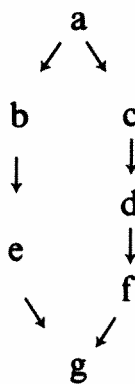

We are criticising not only the artificiality of the quantification-theoretical translations of such sentences<sup>192</sup>, but also the inability of predicate logic to provide any direct representation of the grammatical inferences involved. Within our framework these inferences are simple and immediate applications of the sub-formula rule stated above:

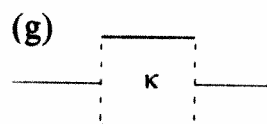
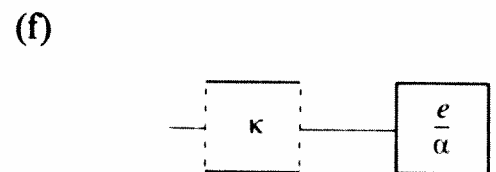
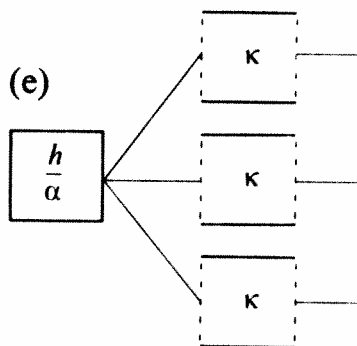
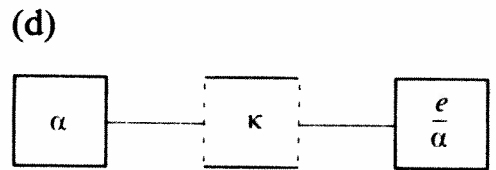
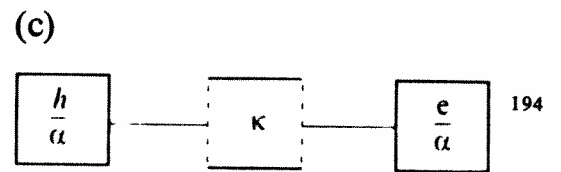
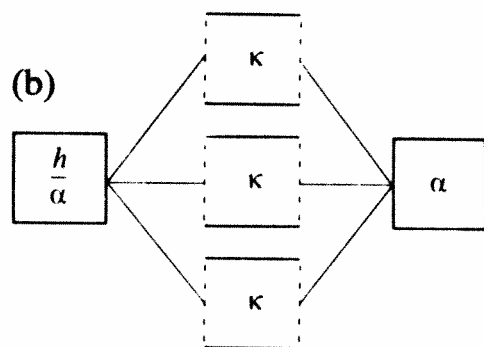
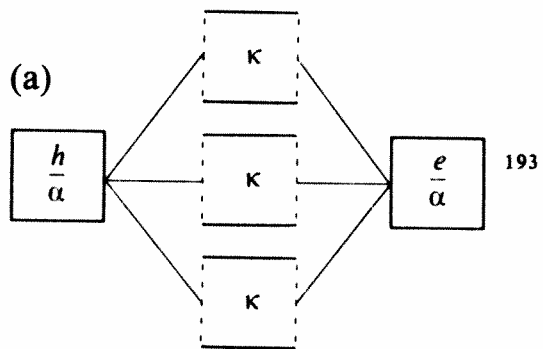

The converse of the sub-formula rule: *from  $\Gamma$  and  $\Delta$  infer  $\Xi$* , whose parts are precisely the parts of  $\Gamma$  and  $\Delta$  cannot, however, be accepted. For consider the two formulae

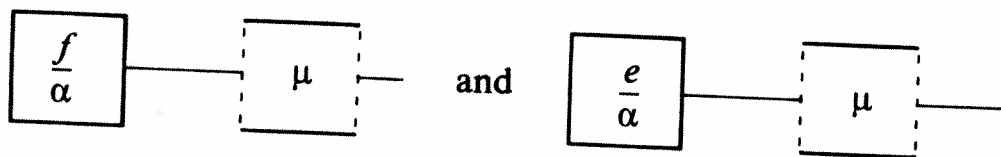

i. e. 'Franz is married' and 'Erna is married'. The composite of the two states of affairs pictured by these formulae would be represented by:

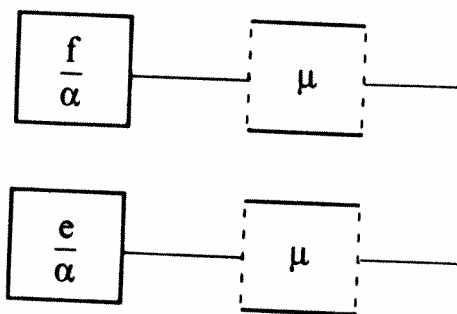

which presupposes (in a directly depicting language<sup>195</sup>) that two (distinct) accidents of marriage are involved. This presupposition rules out the possibility that Franz and Erna are married to each other. From

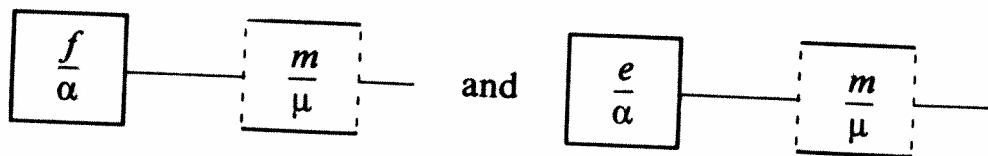

however, i. e. from the propositions which involve the presupposition that the same accident of marriage inheres in both Franz and Erna, we may infer:

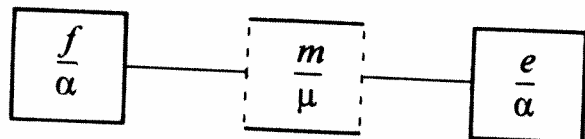

This suggests that we adopt the rule: *from  $\Gamma$  and  $\Delta$ , two propositional formulae having only properly (as opposed to generically) designating*



*sub-formulae in common, infer  $\Xi$ , whose parts are precisely the parts of  $\Gamma$  and  $\Delta$ .*<sup>196</sup>

The rule-schemata so far considered are purely formal in nature: they apply to all material contents (to all formulae, irrespective of the common noun expressions they may contain). Grammatical deduction however typically rests also upon certain material rules of inference, i. e. on rules of inference specific to the *matters* (or associated common noun expressions) involved. This is in virtue of the fact that such matters are not implicatively independent of each other. From 'Hans kisses Erna', for example, we may infer 'Hans does something (is physically active in relation) to Erna', and in general, wherever ' $\kappa$ ' occurs in a valid propositional context, the substitution of ' $\varphi$ ' (for 'physical action in relation to') is validity-preserving:

$$\frac{---\kappa \dots}{---\varphi \dots}$$

Similarly from either 'Hans has pyopericarditis ( $\pi$ )' or 'Hans has paroxysmal tachycardia ( $\tau$ )' we may infer 'Hans has (a) cardiovascular disease ( $\gamma$ )', and from this we may infer 'Hans has a disease ( $\delta$ )'. I. e., in general:

$$\frac{\frac{---\pi \dots \quad ---\tau \dots}{---\gamma \dots}}{---\delta \dots}$$

A system of material substitution rules typically exhibits the structure of a tree, (isomorphic to the structure of the Porphyrian tree constituted by the material essences associated with the common noun expressions which are involved).<sup>197</sup>

There are not only vertical relationships amongst essences but also horizontal relationships, i. e. relationships of dependence between essences, for example between the hue ( $\chi$ ), saturation ( $\sigma$ ), and brightness ( $\beta$ ) of a given colour-moment ( $\gamma$ ), and between the colour-moment and a moment of extension ( $\epsilon$ ). These give rise to further categories of material inference rules. Thus from

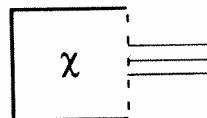

we can first of all infer

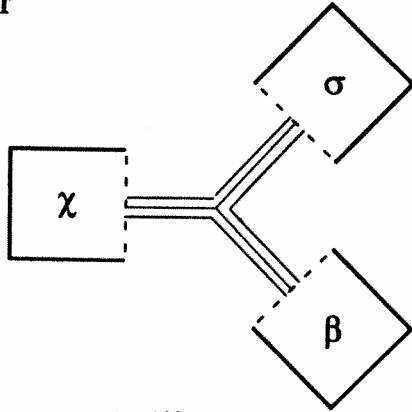

from which we can in turn infer<sup>198</sup>

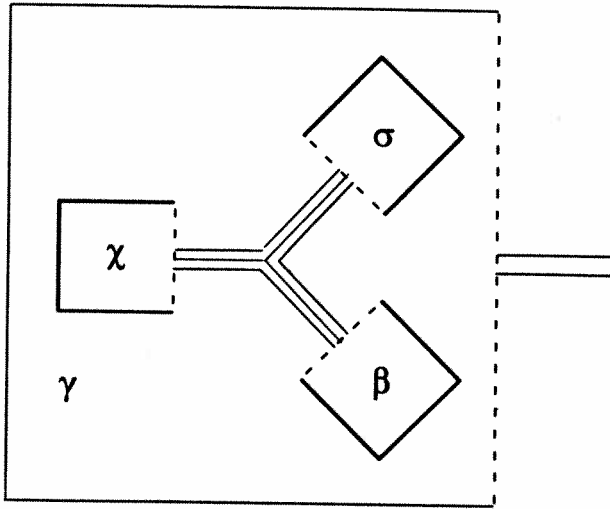

and finally

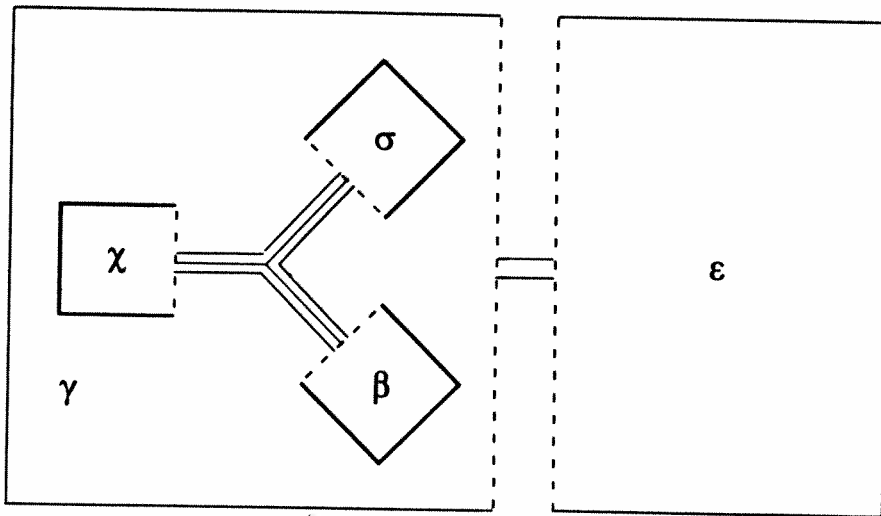

It remains to consider briefly the relationship between the two-dimensional system sketched above and the logic of Euler diagrams. Clearly there is no problem in principle in incorporating overlapping figures into the present framework, along with other elements of the Euler system which preserve the properties of a directly depicting language. A number of formidable combinatorial problems are raised, however, as soon as we begin to investigate the inferential structure of the language which results.

Thus whilst from, say,

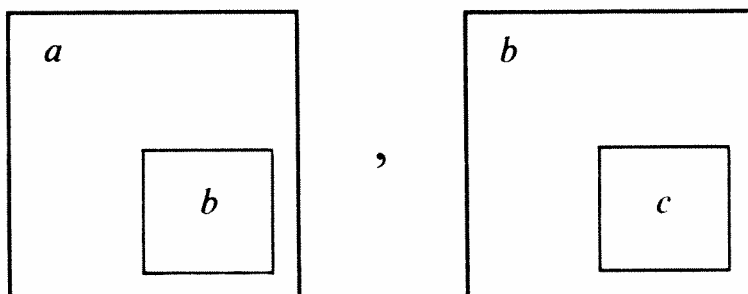

we may unproblematically infer

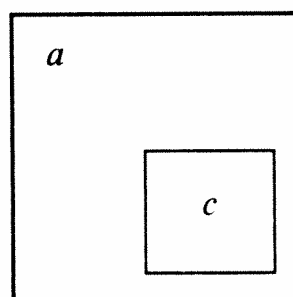

and from

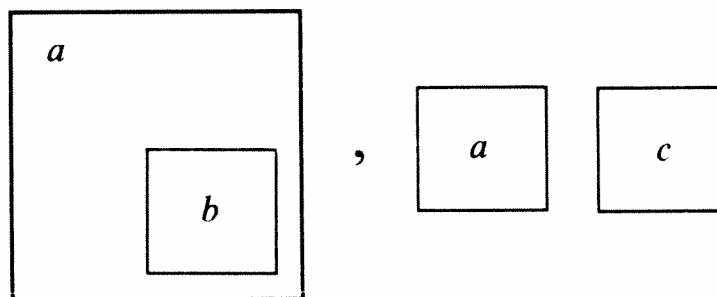

infer

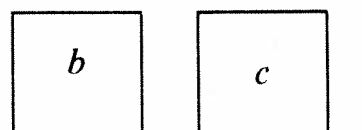

no similar unproblematic conclusion concerning the relation between  $a$  and  $c$  can be drawn from

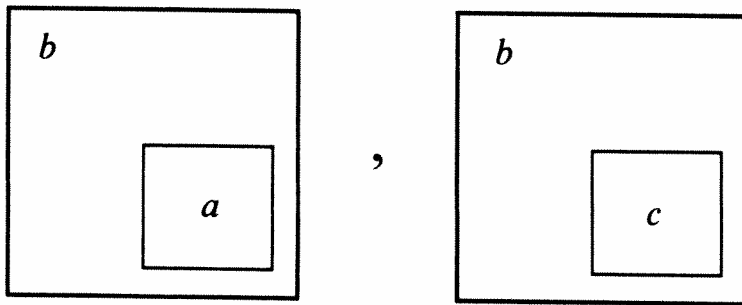

At best we can infer something of the form:

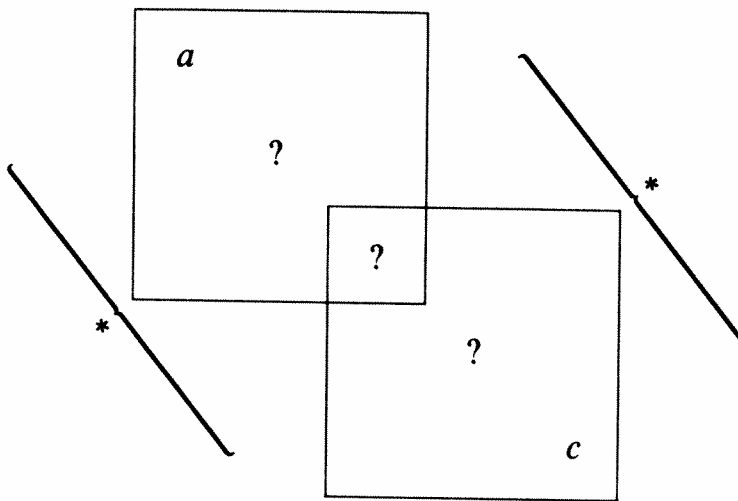

where '\*' and '?' signify, respectively, 'is known to be occupied' and 'is not known to be occupied'. Not only does the introduction of '\*' and '?' threaten to involve a radical departure from the principles of a directly depicting language; it also places almost insuperable difficulties in the way of any statement of the inference rules of the resultant system.<sup>199</sup>

This completes our sketch of one possible symbolic framework for formal ontology. Issues not considered include the linearisation of systems of this sort,<sup>200</sup> and they include the relation of the formal ontology presupposed here to other formal ontological theories, for example the formal ontology of measurement (the theory of extensive and intensive magnitudes), the formal ontology of probability and possibility, of fusion or *Verschmelzung*, and of time and causality. We hope to take up these problems in future investigations.

## Notes

- <sup>1</sup> In Wittgenstein's words (*Tractatus*, 4.221): "wie kommt der Satzverband zustande?"
- <sup>2</sup> References given in this form are to works listed in the bibliography of writings on whole-part theory at the end of the volume. References to works not in this bibliography are given in full in the notes below.
- <sup>3</sup> A detailed analysis of the various form-matter concepts in the tradition is given by Ingarden in ch. 7 of his 1964/65.
- <sup>4</sup> Compare Leśniewski, 1929, p. 14, and Gardies, 1975.
- <sup>5</sup> This classification of accidents, due to Wolfgang Degen, closely resembles the classification of Gestalt-qualities given by Ehrenfels in his 1890. Compare also the appendix to Smith, 1981.
- <sup>6</sup> Cf. I. Angelelli, "On Individual Relations", *Studia Leibnitiana*, forthcoming. Angelelli contrasts what he calls the Siamese twin theory of relational accidents with the belief in the reality of (individual) relational states of affairs, propounded for example by Aquinas. Without such relational states of affairs "there is no real 'order' among the *entia* in the world" (§ 2). Cf. also Habel, 1960, part 2.
- <sup>7</sup> *Wissenschaftslehre*, § 127: "Closer consideration shows that *all* propositions have three parts, a subject-idea, the concept of having, and a predicate idea, as indicated in the expression '*A* has *b*'."
- <sup>8</sup> See also § 58 on mediate and immediate parts, and compare §§ 18 ff of Husserl's 3rd Logical Investigation.
- <sup>9</sup> See especially §§ 9 f of Twardowski, 1894. On the influence of Twardowski, Marty and Husserl on Leśniewski and other Polish logicians see Dąbmska, 1978, Luschei, 1962, Surma, 1977 and § 5.1 below.
- <sup>10</sup> On the influence of Bolzano on Husserl see § 9 of the latter's 1913. It is worth mentioning that, along with Brentano and Twardowski, Husserl was principally responsible for the rediscovery of Bolzano's logic after his work had lain fallow for several decades.
- <sup>11</sup> See the introduction to the bibliography at the end of this volume, and especially the diagram on p. 87.
- <sup>12</sup> Compare Twardowski, 1894, § 12 "Das Verhältnis des Vorstellungsgegenstandes zum Vorstellungsinhalt".
- <sup>13</sup> Cf. also Fechner, *Über die physikalische und philosophische Atomenlehre*, 2nd ed., Leipzig: Mendelssohn, 1864, p. 260, and Husserl, LU V, § 18:  
"Not every unitary experience compounded out of acts is for that reason a *compound* act, just as every concatenation of machines is not a compound machine. . . . A compound machine is a machine compounded out of machines, but so compounded, that it has a total performance into which the performances of the partial machines flow, and the like is the case in regard to compounded acts."
- <sup>14</sup> Such complexes are illustrated by the kind of intermeshing depicted in, say, a model of a traffic accident or in a drawing of a pair of swordsmen *en face*: for a discussion of the place of these examples in Wittgenstein's philosophy see Smith, "Law and Eschatology in Wittgenstein's Early Thought", *Inquiry*, 21, 1979, 425-41, esp. p. 428. On the influence of legal science in the universities of Central Europe see Smith, "On the Production of Ideas. Notes on Austrian Intellectual History from Bolzano to Wittgenstein", in Smith, ed., 1981, 211-35; "Kafka and Brentano: A Study in Descriptive Psychology", *op. cit.*, 113-60; and also "Law and Eschatology", pp. 425 ff.
- <sup>15</sup> We shall return to this discussion of dependence relations amongst the elements of legal and other complexes in the introduction to the essay by Reinach below. Being,

1906 and Bierling, *Juristische Prinzipienlehre*, 5 vols., Freiburg and Leipzig: Mohr, 1894/1917, esp. vol. 1, provide a mass of examples of such *a priori* dependence relations in the fields of criminal law and of civil and constitutional law respectively. The philosophical foundations of this conception of the objects of law are set forth by Reinach in his "Die apriorischen Grundlagen des bürgerlichen Rechts", 1913, discussed in § 3 of the introduction to the essay "On the Theory of the Negative Judgment". On *a priori* tendencies see Duncker, 1941.

<sup>16</sup> A *Rechtsverhältnis* is simply that kind of *gegenseitig sich zu einander Verhalten* amongst individual subjects within the world which is, against the background of a given legal system, a legally relevant whole.

In the classical account, presented by Savigny in his *System des heutigen römischen Rechts*, 9 vols. (of which seven are devoted to the study of various types of *Rechtsverhältnisse*), Berlin: Veit, 1840/49, the matter or *Stoff* of a *Rechtsverhältnis* is distinguished from its form, i. e. from the 'juridical determination of this stuff', through which 'underlying factual relations between individuals are elevated to the form of law'. Bierling, op. cit., distinguishes amongst the mutual relations of human beings in general *Rechtsverhältnisse* (obligations, claims, matrimonial and property relations, etc.) and *spontaneous* relations amongst individuals which admit of no juridical articulation; see esp. vol. 1, p. 194 *et passim*. His full classification of *Rechtsverhältnisse* is given on pp. 275–331. Most important, for our purposes, is his distinction between one-sided and n-sided *Rechtsverhältnisse*, his account of *Teilverhältnisse* (p. 316) and of *Rechtsverhältnisse höherer Ordnung* (pp. 327 ff). Compare also his analysis of causality in the realm of legally relevant states of affairs in vol. 3.

This ontological classification of *Rechtsverhältnisse* by philosophers of law in the 19th century ran parallel with the classification by logicians of the *Grundverhältnisse* – above all the substance-accident relation and the relations of causality and of space and time – amongst objects in general. See above all Beneke's *System der Logik*, part 1, Berlin: Dümmler, 1842. On the relations between these two traditions, – which merged in the *Sachverhalt*-ontologies developed by Stumpf and by the early phenomenologists, especially Husserl, Pfänder and Reinach – see the article "Sachverhalt. I" in K. Gründer, ed., *Historisches Wörterbuch der Philosophie*, Basel: Schwabe, forthcoming.

<sup>17</sup> 2nd ed., Leipzig: Breitkopf and Härtel, 1869.

<sup>18</sup> Op. cit., vol. II.2, pp. 328 ff. Cf. also 4th ed., vol. III. 1, pp. 182 ff. The passage quoted is discussed at length in Engisch, 1953, ch. 5, pp. 238 ff.

<sup>19</sup> Cf. n. 13 to Smith, "Law and Eschatology".

<sup>20</sup> The influence of Boolean/Schröderian ideas on mathematicians and philosophers, and particularly of Schröder's *Algebra der Logik* on Husserl (see his 1890, 1891a, 1908/09) and on Skolem and Löwenheim, has perhaps been insufficiently emphasised. One remnant of the Boolean algebra of classes appears in Bernays' and Gödel's theories of sets and classes (see P. Bernays, "A system of axiomatic set theory. I", *Journal of Symbolic Logic*, 2, 1937, 65–77 and K. Gödel, *The Consistency of the Continuum Hypothesis*, Princeton: Princeton U.P., 1940). Where within (first order) Zermelo-Fraenkel set theory one has to adopt for each first order property a separate replacement axiom, in the Bernays-Gödel theory one has a single replacement axiom for classes, from which individual replacement axioms for all first order properties of sets can then be derived. This is achieved by systematically replacing such properties by classes derived from other classes by means of operations which mirror the operations of the algebra of logic.

<sup>21</sup> In modern properly mathematical work in set theory the distinction between  $\in$  and  $\subseteq$  has, ironically enough, ceased to play any crucial role, since the levels of the cumulative hierarchy which form the objects of mathematical investigation are all of them

transitive sets, so that the systems of structural relations generated respectively by  $\in$  and  $\subseteq$  prove to be mathematically interchangeable.

- <sup>22</sup> And cf. the third of Simons' three papers below. Cf. also Simons, 1980.
- <sup>23</sup> This pragmatic standpoint has come to imply that set theory is no longer conceived as a theory which describes its own appropriately structured world; it is conceived rather as an arsenal of mathematical tools with the help of which other, quite heterogeneous mathematical theories (arithmetic, analysis, topology, etc.) can be built up. But this implies that, with respect to any single mathematical theory, set theory is superflously strong, its object-universe monstrously overgrown.
- <sup>24</sup> It may be helpful in what follows provisionally to identify 'moment' with 'abstract part', 'piece' with 'concrete part'. Compare § 17 of Husserl's 3rd Logical Investigation where Husserl explains why this identification is of only limited validity.
- <sup>25</sup> See e.g. Drobisch, *Neue Darstellung der Logik nach ihren einfachsten Verhältnissen*, 4th ed., Leipzig: Voss, 1875, part 1, *passim*; Ueberweg, *System der Logik und Geschichte der logischen Lehren*, 4th ed., Bonn: Marcus, 1874, § 4, "Das Merkmal und die Theilvorstellung".
- <sup>26</sup> In the light of the discussion of German legal ontology in § 1.3 it is interesting that Stumpf began his university career as a student of law (see Lewin, 1937). Stumpf's pupils in psychology included Wertheimer, Köhler and Koffka, who went on to found the Berlin School of Gestalt psychology. As a philosopher however (cf. his 1906 f and 1939/40, see also the work of E. Becher), he has had an almost negligible influence. This is to a large extent a result of the fact that his philosophical method – which in some ways resembles the piecemeal conceptual clarification of contemporary analytic philosophy – was alien to the German intellectual climate of the inter-war period.
- <sup>27</sup> "Were they merely members of a sum, then it would perhaps be conceivable, to put it simply, that when the extension disappears, so too does the quality (that they do not exist independently); but that the quality disappears gradually in this way, and disappears – without its changing as a quality – with the mere decrease and disappearance of the quantity, would be incomprehensible" (op. cit., p. 113).
- <sup>28</sup> Stumpf has 'Stärke' instead of 'saturation' [*Sättigung*]. Cf. Stumpf, 1917.
- <sup>29</sup> Such that they "... merely keep each other company as a matter of habit..." (Stumpf, 1939/40, vol. 1, p. 183).
- <sup>30</sup> I. e. precisely the Wertheimer-Köhler-Koffka Gestalt psychology; see § 6 below.
- <sup>31</sup> This corresponds to an underlying Spinozist metaphysic: cf. Stumpf's "Spinozastudien", *Abhandlungen der preussischen Akademie*, Berlin, 1919. Compare also the entry for 1. 8. 1916 in Wittgenstein's diary: "Gott ist, wie sich alles verhält" (*Notebooks 1914–16*, p. 79). On one-sided correlations see Stumpf, 1899, 1907, 1916.
- <sup>32</sup> For a full account of the evolution of Stumpf's early thought it would be relevant to note that Lotze, who supervised Stumpf's work on presentation of space, had anticipated the bare outlines of its general approach – albeit within a semi-idealistic framework – particularly in his work on local signs in spatial perception.
- <sup>33</sup> Brentano, *Die Psychologie des Aristoteles, insbesondere seine Lehre vom Nous Poietikos*, Mainz: Kirchheim, repr. Darmstadt: Wissenschaftliche Buchgesellschaft, Eng. trans. by R. George, Berkeley: University of California Press, 1977.
- <sup>34</sup> See also Smith, 1981, § 2 and G. Küng, 1978.
- <sup>35</sup> Brentano, *Wahrheit und Evidenz*, ed. O. Kraus, Leipzig: Meiner, 1930, Eng. trans., *The True and the Evident*, London: Routledge and Kegan Paul, 1966.
- <sup>36</sup> *Psychologie*, book 2, ch. 6.
- <sup>37</sup> The Brentanian treatment of complete and incomplete expressions (cf. Marty, 1908), can usefully be contrasted with Frege's historically more influential treatment of sentential parts.
- <sup>38</sup> Brentano, *Psychologie*, chs. 5–7, *Vom Ursprung sittlicher Erkenntnis*, 3rd ed., with in-

roduction and notes by O. Kraus, Leipzig: Meiner, 1934, p. 57; and cf. Heinrich, 1910, p. 10f. for a discussion of the relation between Brentano's views and those of Husserl, especially as put forward in the 5th Logical Investigation.

<sup>39</sup> *Psychologie*, book 2, ch. 7.

<sup>40</sup> Thus Brentano's philosophy influenced the development of Kotarbiński's 'reism' or 'concretism' (see the latter's 1929).

<sup>41</sup> It is striking how much recent philosophy has returned to ideas first spelled out by Brentano around the turn of the century. This is particularly true of his commitment to an ontology of material things and persons, of the great stress he laid on linguistic analysis (see R. Haller, "Brentanos Sprachkritik", in *Die Philosophie Franz Brentanos*, R. M. Chisholm and R. Haller, eds., Amsterdam: Rodopi, 1978, 211–24), and also of his notion of the reflexivity of representation, which has surfaced in recent work on the pragmatic component in a theory of meaning (see F. Récanati, *La transparence et l'énonciation: pour introduire à la pragmatique*, Paris: Seuil, 1979, e.g. §§1 and 9). For Brentano, when I hear a sound (the primary object of my act of hearing), I am also obliquely aware of another object, namely this act itself (the secondary object in Brentano's terms). Similarly a linguistic act involves not only a content or reference but also an indication by the speaker of the sort of act involved. Kastil summarises Brentano's view as follows: "... when I say 'A exists' I want the person I address to judge that I believe in A ('s existence) . . . the attempt to communicate is always double and what is communicated secondarily is a judgment concerning ourselves. Exclamations, requests and orders are also communications of judgments about what is going on in me. They are abbreviations of 'I am conscious of the wish that something should exist', etc.'" (*Die Philosophie Franz Brentanos*, Bern: Francke, 1951, p. 100).

<sup>42</sup> See Brentano, 1978, and the introduction to this work by Chisholm and Körner. Cf. also Kastil, op.cit., ch. 5. It is in the contrast between their respective treatments of the continuum that the comparison between Brentano and Husserl on part-whole relations is most fruitful. Briefly, where Brentano's treatment centres around the concept of a boundary, Husserl distinguishes what he calls moments of (spatial or temporal) extension. A moment of extension has the following property, possessed by no other moments, that it, and moments founded on it, can be pieced (see § 3 below).

<sup>43</sup> This emphasis on structural relations signified a radical break with the subject-object centred tradition of German idealism. The neglect of Husserlian whole-part theory and of the work of e.g. Selz or Burkamp is almost certainly to be ascribed to the continuing dominance of this tradition far into the 20th century.

<sup>44</sup> Cf. E. Heinrich, 1910, §§13 f, and § 16 of Husserl's 3rd Logical Investigation.

<sup>45</sup> Even here however Brentano did not conceive his work as contributing to a theory of wholes and parts as such. Following Aristotle, he regarded his work much more as a contribution to the theory of relations (or, better, of *relativa*: cf. *Kategorienlehre*, pp. 166–99, *Raum, Zeit und Kontinuum*, part 2, essay 8, "Das Zeitliche als Relatives", and Kastil, op. cit., p. 132f). Examples of *relativa* include a cause and its effect, the parts of a collective and the collective itself, a continuum and its boundary, a thinker and a thought, and all comparatives. The concept thus has the same extension as 'foundation relation' in Husserl (see § 3 below). Husserl however saw clearly that the concept of foundation relation is a formal concept (applying to all matters whatsoever), and he was explicit that his theory represented "a segment of the *a priori* theory of wholes and parts, i.e. of forms of connection (*Verbindung*) and unity in general" (Husserl, 1913, p. 131).

<sup>46</sup> Accidents, that is to say, fall outside the universe of discourse of any scientific theory, (a view which echoes, of course, the opinion of Aristotle). Thus despite the subtlety of Brentano's concept of *thing* he suffers, in the end, from the same kind of naturalism criticised by Husserl in Part I of the *Krisis*. The analytic philosopher's emphasis on ma-



terial things (or, more generally, on the bearers of proper names) is a related form of this naturalism.

- <sup>47</sup> See Marty, 1884/95 and 1908, and also Kraus, 1930, in which Brentano's and Marty's work on syncategoremata and on *Sachverhalte* is compared with Russell's early philosophy and with the *Tractatus*.
- <sup>48</sup> On the influence of Schröder on Husserl see the latter's 1890 and pp. 180–93 of his 1908/09. More general information on Husserl's mathematical background is provided in Scrimieri, 1965, Voltaggio, 1965, Husserl, 1907, pp. xxvff and Smith, 1976.
- <sup>49</sup> Compare Cantor's notion of a set as a 'collection into a whole (*Zusammenfassung zu einem Ganzen*) of definite and separate objects of our intuition or our thought' ("Beiträge zur Begründung der transfiniten Mengenlehre", *Mathematische Annalen*, 46, 1895/97, 481–512, 49, 207–46, as repr. in Cantor's *Gesammelte Abhandlungen mathematischen und philosophischen Inhalts*, Hildesheim: Olms, 1966, p. 282).
- <sup>50</sup> Cf. PdA, p. 19. Here Brentano was drawing on a great deal of contemporary work on ontology in the Aristotelian tradition by, above all, his teacher Trendelenburg.
- <sup>51</sup> Cf. Stout, 1900 and Hicks, 1930/31. Contrast this approach with e.g. the following passage from Hume's *Treatise*, I, part IV, sect. III, "Of the Ancient Philosophy": '... our ideas of bodies are nothing but collections formed by the mind of the ideas of the several distinct sensible qualities, of which objects are composed, and which we find to have a constant union with each other.'
- <sup>52</sup> Cf. *Tractatus*, 2.021: "Objects make up the substance of the world. That is why they cannot be composite," and Trendelenburg, *Logische Untersuchungen*, 3rd ed., Leipzig: Hirzel, 1870, vol. 1, p. 185.
- <sup>53</sup> Cf. § 1 of the first edition of LU III (Passage deleted in second edition) and compare also *Ideen*, I, § 12 and the discussion of *Morphenverschmelzung* in Héring, 1921, ch. 2.
- <sup>54</sup> Husserl told Kneale, on a visit to Freiburg in 1928, that the 3rd Logical Investigation was the best starting point for a study of his works. See *Journal of the British Society for Phenomenology*, 2, 1971, p. 78. In the forward to the second edition of the *Logical Investigations* Husserl wrote of the 3rd Investigation: "I have the impression that this Investigation is all too little read . . . it is an essential presupposition of the full understanding of the Investigations which follow". Cf. also Holenstein, 1973, *passim*.
- <sup>55</sup> The *Logical Investigations* are dedicated to Stumpf, Husserl's teacher and colleague in Halle from 1886. During his time in Halle, Husserl was on friendly terms also with Hermann Grassmann, and with Cantor (see Schuhmann, *Husserl-Chronik*, p. 22 and A. Fraenkel, "Das Leben Georg Cantors", in Cantor, *Gesammelte Abhandlungen*, p. 477). Stumpf and Cantor were indeed, with the physicist Knoblauch, Husserl's Habilitation examiners (Stumpf examining Husserl on topics which included Lotze's theory of spatial perception, the history of theories of space, and the relations between mathematics and logic – Schuhmann, *op. cit.*, p. 19). Nothing is known of any contact between Cantor and Stumpf. The mathematical works published by Stumpf in this period under the influence of Felix Klein ("Über die Anwendung des mathematischen Wahrscheinlichkeitsbegriffes auf Teile eines Kontinuums" and "Über den Begriff der mathematischen Wahrscheinlichkeit", both published in the *Sitzungsberichte der bayerischen Akademie der Wissenschaften* for 1892) had an incidental philosophical significance in that they influenced mathematicians such as Czuber to conceive probability statements as relating not to events but to statal entities (*Tatbestände* or, to use the term favoured by Stumpf, *Sachverhalte*). See e.g. pp. 5, 85 of Czuber's *Wahrscheinlichkeitsrechnung und ihre Anwendung auf Fehlerausgleichung, Statistik und Lebensversicherung*, Leipzig: Teubner, 1903.
- <sup>56</sup> The concept of variation as a mode of gaining knowledge of essences played a crucial role in Husserl's later philosophy and in that of his students (see e.g. the account in E.

- Swiderski, "Some Salient Features of Ingarden's Ontology", *Journal of the British Society for Phenomenology*, 6, 1975, 81-90, esp. p. 87 f). It was anticipated by Bolzano (*Wissenschaftslehre*, § 147) and appears already in Husserl's 1894, an important connecting link between the *Philosophy of Arithmetic* and the *Logical Investigations*.
- <sup>57</sup> Cf. § 2 of LU III. In his translation of the *Logical Investigations* Findlay coined the term 'non-independent', as a translation of Husserl's *unselbständig* which would bring out the negativity of the latter (see p. 39 of his introduction). Our reasons for preferring the straightforward 'dependent' are given by Simons in his introductory note to the essay by Ginsberg translated below.
- <sup>58</sup> These essences exist autonomously, i.e. independently of all cognitive acts (and thus, *a fortiori*, of the linguistic conventions or grammatical rules adopted by subjects who may gain access to them). See Ingarden, 1925 and 1964/65, vol. II/1, and Swiderski, op. cit.
- <sup>59</sup> At least some of these truths are, we shall argue, not only *a priori*, but also synthetic. We do not however wish to rule out the possibility that others may belong to the realm of the analytic *a priori* as this is delineated by Husserl. See § 4 below and Smith, 1981.
- <sup>60</sup> Unpublished work by Wolfgang Degen on the formal ontology of quantum mechanics suggests that it may be fruitful to regard certain types of purported sub-atomic particles as dependent moments of more familiar entities.
- <sup>61</sup> See Husserl, *Ideen I*, § 11.
- <sup>62</sup> Compare Ehrenfels, 1890, the paper which instigated Meinong's introduction of the terminology of foundation.
- <sup>63</sup> See the discussion of representation on pp. 782-800 in Reinach, 1913, and § 4 of the introduction to the essay by Reinach below.
- <sup>64</sup> This aspect of part-whole theory is stressed by Burkamp in his 1929.
- <sup>65</sup> A preliminary classification of more than one thousand different types of whole is presented by Rausch in his 1937. See § 6 below.
- <sup>66</sup> This example is taken from Ingarden, 1964/65, vol. I, § 15.
- <sup>67</sup> See n. 72 below.
- <sup>68</sup> Findlay translates Husserl's 'Satz' (in '1. Satz', '2. Satz', etc.) by 'Proposition' which draws attention away from the fact that Husserl provides a proof of all but Theorem I (which he finds axiomatically self-evident). This fact is further obscured in the English edition by the typographical running together of the proof of Theorem VI with the statement of the theorem. This edition also has 'subordinate' in place of 'superordinate' in Theorem II.
- <sup>69</sup> Compare § 84 of the *Wissenschaftslehre*.
- <sup>70</sup> In his *A History of Experimental Psychology*, 2nd ed., New York: Appleton-Century-Croft, 1950, E. G. Boring speaks of a nativist tradition in psychology standing in opposition to the empiricist tradition of, say, Hume, Lotze, Helmholtz, Wundt und Külpe. Nativism had its origins in Kant's theory of space and also in work on colour-theory by Goethe and Purkinje. Its principal representatives were Johannes Müller, E. Hering (successor of Purkinje in Prague), Mach and Stumpf (also both for a period holders of chairs in Prague), and the Gestalt-psychologists Wertheimer, Koffka and Köhler.
- <sup>71</sup> The following distinctive features of the English (stop) consonantal system: ± Labial, ± Dental, ± Velar, are mutually incompatible moments; and they are genuine moments: they never appear in isolation. See § 5 below.
- A relation of foundation is exhibited between the ingredients of *sense*, *tone* and *force* in a linguistic meaning as this is conceived by Frege. They correspond to three distinct dimensions in the geometry of meaning:  
 "a difference between two expressions, or two sentences, in respect of any these three features . . . would ordinarily be accounted a difference in meaning; a mistake about the sense, tone or force intended to be understood as attached to a sentence or expres-

sion would ordinarily be accounted a misunderstanding of its meaning” (Dummett, *Frege. Philosophy of Language*, London: Duckworth, 1973, p. 84).

Appeal is made to the concept of foundation also – we suggest – by Strawson, in his account of the *statement* as an action or event standing (in effect) in internal relations to the circumstances in which it is made; see D. Willard “Husserl’s Critique of Extensionalist Logic: ‘A Logic that does not understand itself’”, *Idealistic Studies*, 9, 1979, 143–64, pp. 154f, Tugendhat, 1976 and Mulligan, 1980. It is remarkable how seldom analytic philosophers have paused to reflect on the ontological presuppositions of their talk of ingredient, dependence, aspect, feature, etc.

<sup>72</sup> Here, as elsewhere, lower case italic Roman letters are proper names of individual existents. Lower case Greek letters are common nouns or common noun phrases, signifying species or types (*middle C*, *prussian blue*, etc.).  $\frac{a}{\alpha}$  may be read, according to con-

text: ‘*a* which is (an)  $\alpha$ ’, ‘*a*, *qua* or in its capacity as  $\alpha$ ’. (A similar notation is suggested by Husserl in his 1908/09.) The broken lines signify mutual dependence relations amongst the contents designated. The form of representation given in the text is inadequate in a number of ways. In any complete account it would be necessary, for example, to distinguish between *n*-sided mutual dependence amongst moments and an *n*-fold pairwise dependence amongst the moments taken separately. It would be necessary also to distinguish relations of dependence obtaining amongst species *in abstracto* (where part-whole imagery may be out of place) from the corresponding relations obtaining amongst factual instantiations (*a qua*  $\alpha$ , *b qua*  $\beta$ , etc.). Two pictures would then be necessary: a picture of the relevant *Wesensverhalt* on the level of essence, and a correspondingly articulated picture of the underlying individual *Sachverhalt* on the level of fact. A more detailed account of the directly depicting language which then results – taking dependence-diagrams as propositional signs in the sense of the *Tractatus* – is given in § 6.4 below.

<sup>73</sup> See especially his *Zur Lehre vom Lichtsinne; sechs Mittheilungen an die Kaiserliche Akademie der Wissenschaften in Wien*. Vienna: Gerold, 1878, and for further references pp. 115 and 379 of Boring, op. cit., and also Stumpf, 1918.

<sup>74</sup> It was originally Herbart who recognised that expressions such as ‘between’, ‘among’, ‘high’, ‘low’, ‘side’, etc., having their primary meaning in the geometrical sphere, can be used non-metaphorically for all quality continua. Cf. also the work on quality-spaces by Helmholtz, e.g. his “Kürzeste Linien im Farbensystem”, *Zeitschrift für Psychologie*, 3, 1892, 108–22. The idea of a *Farbengeometrie* was developed systematically by Meinong in his “Bemerkungen über den Farbenkörper und das Mischungsgesetz”, *Zeitschrift für Psychologie*, 33, 1903, 1–80, repr. in GA I. Cf. also Stumpf’s *Tonpsychologie*, 1883/90, esp. vol. I, 189, his 1906a, p. 28f, Gilman, 1892, Selz, 1930ff, and Mulligan, 1980. Against this background the apparent gulf between Husserl’s formal ontological work on the theory of manifolds and his more strictly phenomenological writings on perception disappears completely.

It is perhaps worth pointing out that the word ‘*Farbenraum*’ employed by Meinong (loc. cit., § 5, “Die Farbenraum und seine Dimensionen”) is used also by Wittgenstein, e.g. at 2.0131 in the *Tractatus* and on p. 51 of the *Philosophische Bemerkungen*.

<sup>75</sup> Stumpf employed the term ‘phenomenology’ to designate one such *Vorwissenschaft* – that which would explore the domain of possible contents of immediate sensory and memory experience. Given the considerable influence amongst experimental psychologists of the lecture “Zur Einteilung der Wissenschaften” in which this theory of descriptive *a priori* sciences is set out, it is interesting to note the similarities between Stumpf’s use of ‘phenomenology’ and the use made of it by Wittgenstein (cf. Spiegelberg, “The Puzzle of Ludwig Wittgenstein’s *Phänomenologie* (1929–?)”, *American Philosophical Quarterly*, 5, 1968, 244–56). “Physics”, writes Wittgenstein, “differs from

phenomenology by its aim of establishing laws. Phenomenology establishes merely possibilities. Thus phenomenology would be the grammar for the description of those facts upon which physics erects its theories" (*Philosophische Bemerkungen*, p. 51). "Physics wants to establish regularities; it does not look for what is possible. This is the reason why physics, even when it is completely developed, does not offer a description of the phenomenological state of affairs. Phenomenology always deals only with possibility, i.e., with meaning, not with truth and falsehood. Physics focuses, as it were, on certain points in a continuum and uses these for constructing a lawlike series. It does not care about anything else" (*Wittgenstein und der Wiener Kreis*, p. 63). "But what kind of a proposition is that, that blending in white removes the colouredness from the colour? As I mean it, it can't be a proposition of physics. Here the temptation to believe in a phenomenology, something midway between science and logic, is very great" (*On Colour*, p. 15, written ca. 1950–51). The possibility of an influence of Stumpf on Wittgenstein has been raised in another context by Smith in his 1978 and also in "Wittgenstein and the Background of Austrian Philosophy", *Wittgenstein and his Impact on Contemporary Thought*, Vienna: Hölder-Pichler-Tempsky and Dordrecht: Reidel, 1978, 31–35.

<sup>76</sup> See e.g. Husserl, 1913, § 6.

<sup>77</sup> The term 'material *a priori*' is used instead of the more usual 'synthetic *a priori*' in order to avoid unnecessary confusion with Kantian uses of this term. An excellent account of the confusion, in Kant's critical philosophy, between logical and material necessity is provided by Reinach in his 1911 (see also the introduction to the essay by Reinach translated below, and also G. Davie, "Edmund Husserl and 'the as yet, in its most important respect, unrecognised greatness of Hume'", in G. Morice, ed., *David Hume Bicentenary Papers*, Edinburgh University Press, 1977, 69–76).

Analytic *a priori* truths in Husserl's sense (see LU III, § 10 ff), are either purely formal laws or the results of specification (substitution) in these. Synthetic *a priori* truths derive their truth from necessary connections not amongst forms, but amongst *matters*; they reflect necessary connections amongst the things referred to, characteristic of some material domain or region. In the terminology of the present essay such connections are referred to as material *a priori* connections.

This line of demarcation may be less than sharp if under 'the results of specification' we allow ourselves to understand not merely those sentences obtained by uniform syntactic substitution (taking 'an  $\alpha$  which is a  $\beta$  is a  $\beta$ ' to: 'an aardwolf which is a predator is a predator'), but also sentences obtained by substitutions resting on problematic semantic equivalences. Consider, for example, the following specification of 'an  $\alpha$  which is a  $\beta$  is a  $\beta$ ': 'a declaration which occasions a tendency to bring about  $\Phi$  occasions a tendency to bring about  $\Phi$ '. If we can endorse some semantic equivalence along the lines of:

*act of promising to do  $\Phi$   $\equiv$  declaration which occasions a tendency to bring about  $\Phi$*

then this would seem to yield as an ultimate result of specification the apparently synthetic 'an act of promising to do  $\Phi$  occasions a tendency to bring about  $\Phi$ '. What had appeared synthetic would then have to be counted as implicitly analytic. Compare *Wissenschaftslehre*, § 148, Note 1, where Bolzano grapples with a similar problem.

<sup>78</sup> Cf. e.g. *Ideen I*, § 49: "Consciousness . . . must be reckoned as a *self-contained system of being, a system of absolute being*, into which nothing can penetrate, and from which nothing can escape; which has no spatio-temporal exterior, and can be inside no spatio-temporal system; which cannot experience causality from anything nor exert causality upon anything . . .". Investigation of the range of possible combinations of dependence and independence between consciousness and world forms the basis of Ingarden's ontology as set forth in his *Der Streit um die Existenz der Welt*. As will have been clear from the passage quoted from Berkeley's *Treatise* at the head of § 2

above, it is not only the metaphysics of phenomenologists which admits of expression in whole-part terms. The absolute idealism of Bradley, to take just one example, is founded upon a theory of internal relations which has many points of contact with the theory of foundation relations here developed, though marred by the lack of any respect for the distinction of matter and form. Bradley held, simply put, that there is only one independent whole (the world), that all other entities are moments (in his eyes inadmissibly abstracted moments) of this whole. At the opposite end of a spectrum of metaphysical positions we would find some form of absolutist atomism, a view according to which the furniture of the universe is constituted exclusively by mutually independent simples (apparent ontological commitment to higher order objects founded on these simples being treated as a dispensable *façon de parler*). The truth, which is to be found in Ingarden, 1964/65, falls between these two extremes. See also § 6.1 below.

<sup>79</sup> See *Ideen II* (Hua IV), pp. 133 f, 253 ff; *Erste Philosophie 1923/24 I* (Hua VII), 403; Kern, *Husserl and Kant*, Haag: Nijhoff, 1964, § 9.

<sup>80</sup> A third early criticism is to be found in the *Philosophie der Arithmetik* (Hua XII), p. 42: "Kant overlooked the fact that many contentual connections (*inhaltliche Verbindungen*) are given to us which do not involve any noticeable trace of synthetic activity bringing them about".

<sup>81</sup> Cf. Ch. 1 of *Ideen III* (Hua V), "Die verschiedenen Regionen der Realität".

<sup>82</sup> In the double sense indicated in the second half of note 72 above.

<sup>83</sup> Cf. the accounts in ch. 1 of Habel, 1960 and in ch. 7 of Gardies, 1975.

<sup>84</sup> Cf. Reinach, 1921a, p. 53 of reprint; Eng. trans., p. 211. Consider also the laws holding in the region of musical tones (as discussed by Stumpf, e.g. in §§ 8 and 10 of vol. 1 of the *Tonpsychologie*); for example the laws relating to the one-dimensionality of the tone-sequence, that given three tones of different pitch, one is always in between the others, etc.

<sup>85</sup> This view is of course already present in Aristotle. Reinach's 1909 Habilitationsschrift on *Wesen und Systematik des Urteils*, the manuscript of which has unfortunately been lost, can be presumed to have contained further steps towards the realisation of this project. The idea of an ontological foundation for logic, which Reinach shared with Pfänder, can be discerned also as underlying Meinong's work on logic and *Gegenstandstheorie*. The project formed the subject-matter of Martin Honecker's *Gegenstandslogik und Denklogik. Versuch einer Neugestaltung der Logik*, Berlin und Bonn: Dümmers, 1921. For an account of the opposition between the (Reinachian) ontological approach to the *a priori* and the logico-grammatical approach of modern analytic philosophy see Delius, 1963. The audacity of Reinach's theory is made manifest – at a time when so much ink is spilt on the synthetic *a priori* by philosophers prepared to acknowledge at most a small fraction of Kant's original range of examples, – in its implication that there are vastly *more* cases of synthetic *a priori* truths than Kant had recognised.

<sup>86</sup> It is clear that in the classification of *a priori* dependence relations sketched briefly in § 1.3 above (text to n.15) the dimension of temporality has to be incorporated: relations of necessitation, exclusion, etc., may hold between moments standing in determinate relations of succession. A complete classification would thereby exhibit at least three dimensions: according to the type of relation involved (necessitation, exclusion, etc.); according to the temporal structure of the relevant moment-whole; and according to the formal structure of this whole (which may be one-sided, two-sided, n-sided, etc., or a combination of these). The first dimension has been discussed in detail already by linguists, especially Jakobson and his associates; see Holenstein, 1974, ch. 2, and § 5 below. The second dimension, considered by Husserl in LU III, §§ 13 and 25, is discussed briefly in the introduction to the essay by Reinach translated below; the third dimension in § 6.4 of the present essay.

- <sup>87</sup> Where, in regard to the jigsaw puzzle which is a language, analytic philosophers have been ready to accept that there are complicated restrictions of fit between the constituent elements, they have been less willing to accept the existence of such restrictions in regard to the constituent elements of human life. They have dismissed as accidents of convention such material *a priori* truths as: *it is impossible to flick one's wrist with jealousy* or *all human languages contain words for black and white* or even *all human societies are patriarchal*. This is because what is materially excluded in a given region is often perfectly well *imaginable*, by those who have taken no steps to familiarise themselves with the laws holding in that region.
- <sup>88</sup> Cf. e.g. Strawson, *Individuals*, London: Methuen, 1959, ch. 1 and Tugendhat, *Vorlesungen zur Einführung in die sprachanalytischen Philosophie*, Frankfurt: Suhrkamp, 1976, esp. chs. 23ff.
- <sup>89</sup> This notion of an object's being embedded in a system or net of *Sachverhalte* is discussed, from different formal-ontological points of view, by Ingarden (1931, e.g. § 24 and 1964/65, vol. II/1, ch. XI), Burkamp, 1927, and Hazay, 1915.
- <sup>90</sup> See e.g. Pariente, 1973, Burkamp, 1933, § 188 and B. Erdmann, *Logik*, 3rd ed., Berlin: de Gruyter, 1923, § 169.
- <sup>91</sup> LU III, § 12, Note 1.
- <sup>92</sup> On regional ontologies see Husserl's *Ideen III* (Hua V), ch. 1, and also L. Landgrebe, "Seinsregione und regionale Ontologien in Husserls Phänomenologie", *Studium Generale*, 9, 1956, 313–24. Around 1918 Husserl seems to have worked on a never completed 'philosophical book for mathematicians' and 'mathematical book for philosophers' dealing with the problems of a formal theory of science in relation to the theory of individuation. Cf. Hua, III, 1: "Einleitung des Herausgebers", p. XLVf, and also Beilagen 27 and 30–32 to Hua III, 2.
- <sup>93</sup> See Ingarden, 1935 and 1964/65, III/1.
- <sup>94</sup> See vol. III of Ingarden's *Der Streit um die Existenz der Welt: Über die kausale Struktur der realen Welt*, 1974; compare also § 25 of LU III (1st ed.).
- <sup>95</sup> LU III, § 22. This sentence is used by Jakobson as the motto to his 1940/42.
- <sup>96</sup> See, in particular, Stout's two papers, "Bradley's Theory of Relations" (1900), "Russell's Theory of Judgment" (*Proceedings of the Aristotelian Society*, 15, 1915, 332–52, repr. in Stout, 1930, 239–57) and also Moore's 1919.
- <sup>97</sup> See e.g. his 1960 and 1967.
- <sup>98</sup> See LU III, § 22.
- <sup>99</sup> See Husserl's *Zur Phänomenologie des inneren Zeitbewußtseins (1893–1917)*, Haag: Nijhoff, 1966 (Hua X), e.g. p. 24f. Cf. also Seebohm, 1972 and 1973, and Sokolowski, 1974, ch. 6. Every experienced *now*, Husserl argues, contains as dependent moments a backward-looking *retention* and a forward-looking *protention*.
- <sup>100</sup> Cf. *Ideen II* (Hua IV), summarised in part by Claesges, 1964, §§7f. On Husserl's work on the theory of colours see Piana, 1966. Detailed unpublished material by Husserl on secondary qualities drawing on the whole-part framework is discussed by G. Witschel in his 1964. Husserl distinguishes, for example, between those sense-qualities which, though localisable, do not have an extension which admits of immediate piecing (*Zerstückung*), warmth, for example; and those which do, e.g. colour.
- <sup>101</sup> See part II of Husserl's *Krisis* (Hua VI).
- <sup>102</sup> Cf. also *Ideen I*, §§ 95, 116.
- <sup>103</sup> For an account of the relation between this theory and the formal ontology of part and whole see Smith, 1980a.
- <sup>104</sup> In both LU III and V Husserl carefully distinguished between whole-part relations amongst acts and sensory contents on the one hand, and phenomena of fusion (of qualitative continuity or *Verschmelzung*) on the other. Cf. Stumpf, *Tonpsychologie*, passim, and also e.g. Hicks, 1930/31, and Mulligan, 1980.

- <sup>105</sup> Principles of an ontology of fitting are employed also by Ingarden in his theory of 'pure epistemology' which considers the question: "what conditions must be met by an object and by an act of knowing, if this cognition of the object which is carried out in the given act is to have this or that epistemic value" (*Über die Stellung der Erkenntnistheorie im System der Philosophie*, Habilitationsvortrag, Halle: Karras, Kröber and Nitschmann, 1925, p. 30f. Cf. also his "Über die Gefahr einer Petitio Principii in der Erkenntnistheorie", in *Jahrbuch für Philosophie und phänomenologische Forschung*, 4, 1921, 545–68, and G. Küng, "Zum Lebenswerk von Roman Ingarden. Ontologie, Erkenntnistheorie und Metaphysik", in H. Kuhn, et al., eds., *Die Münchener Phänomenologie*, Haag: Nijhoff, 1975, 158–73.)
- <sup>106</sup> Cf. the passages from § 18 of LU V quoted above, and Ingarden's "The Hypothetical Judgment", *Philosophy and Phenomenological Research*, 18, 1958, 435–50.
- <sup>107</sup> The formal ontology of fitting is related, in particular, to topology. This is seen by the fact that an extensional fragment of this logic is simply the geometry of solid sheets. As primitive terms of this fragment we might select: *fits partially but not perfectly (fits with free play) into, fits perfectly into, is incapable of being fitted into (is skew to)*. Symbolising these relations by, respectively,  $\subset$ ,  $\sqsubset$  and  $\sqsupset$  we can assert, for example, that  $a \subset b \rightarrow \exists x. a \cup x \sqsubset b$ ;  $a \sqsubset b \rightarrow \forall x. a \cup x \sqsupset b$ ;  $a \sqsupset b \rightarrow \forall x. a \cup x \sqsupset b$ . Here 'U' symbolises geometrical colligation. These implications hold, like all truths of geometry, as a matter of *a priori* necessity.
- The topological analogy was exploited – somewhat overenthusiastically – by Kurt Lewin in his *Principles of Topological Psychology*, 1936, which presents a metricised whole-part-theoretical framework within which the relations of fit obtaining amongst psychological formations, particularly those associated with goal-seeking, can be formally expressed.
- <sup>108</sup> The analyses presented in E & U, unlike those in the *Ideen*, represent a true continuation of and advance over those of the 3rd Logical Investigation.
- <sup>109</sup> Cf. E&U §§ 28–32. On the relation between Husserl's concept of absolute substrate and the concept of an absolutely simple object see especially §§ 28f and Piana, 1977. Ingarden, 1925, contains an early, complementary discussion of explication.
- <sup>110</sup> Pfänder's *Logik*, 1921, 182–206, contains a detailed account of the different ontological relations expressed by the copula. Cf. also Husserl, 1952, Beilage 30. Husserl's argument for the introduction of species is presented in LU II.
- <sup>111</sup> Cf. n. 105. It is Ingarden, more than any other philosopher, who has developed Husserl's insight into the possibility of a descriptive epistemology.
- <sup>112</sup> Such material connections will of course be obscured if the object-domains with which one deals consist not of objects (or meanings) themselves, but of set-theoretical models of such objects or meanings. Examples of material connections among meanings are provided e.g. by J. Trier, "Das sprachliche Feld. Eine Auseinandersetzung", *Neue Jahrbücher für Wissenschaft und Jugendbildung*, 10, 1934, 428–49.
- <sup>113</sup> We are grateful to Peter Simons and to Professor Czeslaw Lejewski for their help in the composition of this section.
- <sup>114</sup> See Leśniewski, 1929; Ajdukiewicz, 1935, Rickey, 1972 ff. For a more general account of Leśniewski's work see Luschei, 1962, which also provides ample bibliographical material. For a more historical perspective see Surma, 1977.
- <sup>115</sup> It was Leśniewski who produced the first ever formalisation of the relation of part to whole in the strict sense of 'formalisation' as understood within post-Fregean philosophy. *Formal laws* of this relation had however been expressed by many authors before Leśniewski: the law of transitivity of parts, for example, was formulated by Bolzano, Twardowski and Husserl, and was of course recognised within the Boole-Peirce-Schröder tradition.

- <sup>116</sup> It is only in connection with his *ontology* (see below), that Leśniewski, in his published writings, mentions Schröder.
- <sup>117</sup> *O Zasadzie Sprzeczności u Aristotelesa: Studium krytyczna*, Krakow, 1910.
- <sup>118</sup> This terminology first appears in Kotarbiński, 1929: it appears in Leśniewski's own published works only later.
- <sup>119</sup> He was quite simply unable to make any sense of the axiomatic set theory of Zermelo: see C. Lejewski's article on Leśniewski in P. Edwards, ed., *The Encyclopedia of Philosophy*, 4, 441–43, p. 442.
- <sup>120</sup> A single axiom for mereology on the basis of the primitive 'discrete' was formulated by Lejewski already in 1977: see (c) on p. 62 f and § 7 of the Appendix to B. Sobociński, "On Well Constructed Axiom Systems", *Polskie Towarzystwo Naukowe na Obczyźnie*, *Rocznik*, 6, 1855/56, 54–70. Welsh, 1978, offers a variety of further possible starting places for the same theory of whole and part.
- <sup>121</sup> Note that Leśniewski was not concerned with the explication of the term 'is' as this appears in any actually existing natural language; his aim, rather, was to produce a logically perfected copula, defined exclusively by its behaviour within the system.
- <sup>122</sup> Husserl's reciprocal dependence is thus effectively absent from Leśniewskian grammar. Indeed, a categorial grammar taking 2- or n-sided foundation as basic remains a desideratum even today.
- <sup>123</sup> This development may have received its initial impetus from purely terminological considerations. When the new, strictly formal-logical meaning of the term 'semantics' that had been propounded by Tarski came to be accepted by logicians in the 30's and 40's, the characterisation of Husserlian meaning-categories as 'semantic categories' became no longer viable. Certain elements of the theories inspired by Husserl, Leśniewski and Ajdukiewicz could however properly be designated as 'syntax' under the new dispensation, and it has been these elements, at the expense of investigations of purely formal relations amongst *meanings*, that have continued to be developed by workers in the field.
- <sup>124</sup> See Lejewski, 1973.
- <sup>125</sup> Leśniewski himself conceived protothetic and ontology as properly logical theories, mereology as belonging to mathematics. Nowhere in his published works, however, does he provide a criterion for this distinction.
- <sup>126</sup> To characterise mereology as a true theory implies, of course, that one understands the theory under its intended interpretation. The Leśniewskian approach to logic was, like that of Frege, exclusively a first order approach: the statements of formal logic are conceived as immediately and unproblematically true of the world itself, which is the only model held worthy of consideration. Contemporary logicians, in contrast, ignore the world, directing their attention instead to families of set-theoretic models of logical systems.
- <sup>127</sup> On the and-functor see § 15 of Reinach's "On the Theory of the Negative Judgment" below, Husserl, PdA, p. 75 f, Bolzano, *Paradoxien des Unendlichen*, § 3, and §§ 70–74 of Russell, 1903 (cf. the discussion in § 1.2 of Essay II by Simons, below). On the structure of the hypothetical judgment see Ingarden, "The Hypothetical Judgment", *Philosophy and Phenomenological Research*, 18, 1957/58, 435–50.
- <sup>128</sup> This would in many respects parallel the formal taxonomy of all possible relations between chemical elements as determined by atomic theory: for further discussion of this parallel see § 6.4 below.
- <sup>129</sup> See C. Serrus, *Le Parallélisme logico-grammatical*, Paris: Alcan, 1934, part 2, ch. 5, 317–81, and perhaps also Bar-Hillel, 1956.
- <sup>130</sup> Now collected in Husserl, 1979.
- <sup>131</sup> "Syntaktische Formen und syntaktische Stoffe. Kernformen und Kernstoffe", Hua, XVII, 299–313.



- <sup>132</sup> See Hua, XII, pp. 475, 485 ff, "Das Gebiet eines Axiomensystems/Axiomensystem. Operationsystem", and Mulligan, 1980.
- <sup>133</sup> See LU IV, §§ 12, 14, and the work referred to in n. 131 above.
- <sup>134</sup> The term 'modification' signifies an *a priori* possible meaning transformation (e. g. the nominalisation of a sentential expression such as 'this book is red' to form the nominal 'this red book'). See LU IV, §§ 11, 13, V, §§ 39–40, E&U, § 55.
- <sup>135</sup> Thus Jakobson, for example, distinguishes between phonetics as a *Stofflehre* and phonology as a *Formlehre*: cf. Jakobson, 1939, and compare the remarks on Savigny on p. 93 above. The form/core distinction emerges in the syntax of natural languages as a distinction between syntactic categories and syntactic features.
- <sup>136</sup> See Holenstein, "Prague Structuralism – A Branch of the Phenomenological Movement", in J. Odmark, ed., *Language, Literature and Meaning I: Problems of Literary Theory*. Amsterdam: John Benjamins, 1979, 71–98.
- <sup>137</sup> *Logitscheskija Izsledowanija. Tschastj perwaja. Prolegomeny k tschishoi Logike*, trans. E. A. Berstein and S. L. Frank, St. Petersburg: Obrazovanije.
- <sup>138</sup> See Holenstein, 1975, which contains a full account of Husserl's influence and a discussion of the associated substantive issues. Jakobson also draws on Stumpf's work on the psychology of sound, arguing, for example, that not only colours but also sounds exhibit dimensions of brightness and saturation.
- <sup>139</sup> See e.g. ch. 3 of Holenstein, 1974, and the papers referred to in n. 150 below
- <sup>140</sup> Jakobson, "Un manuel de phonologie générale", 1939, SW I, 311–16, p. 315.
- <sup>141</sup> Jakobson, "Phoneme and Phonology", 1932, SW I, 231–33, p. 231.
- <sup>142</sup> "Un manuel de phonologie générale", loc. cit. Jakobson was able to show that natural languages make use of an inventory of not more than a dozen such distinctive features (Jakobson and Halle, 1956, p. 471 f). These 'inherent features' are distinguished from prosodic features which 'bind the phoneme as such to the time axis', i.e. in the terminology of the 3rd Investigation, necessarily involve a moment of temporal extension.
- <sup>143</sup> On gradual (non-binary) phonological features see T. Vennemann, "On the theory of syllabic phonology", *Linguistische Berichte*, 18, 1972, 1–18.
- <sup>144</sup> Cf. Jakobson, "Retrospect (1961)", SW I, 629–58, p. 645.
- <sup>145</sup> See Jakobson, "The identification of phonemic entities", 1949, SW I, 418–25, p. 421. This point is made also by the phenomenologist and linguist H. Pos in his 1938.
- <sup>146</sup> Jakobson and Halle, 1956, p. 471 f.
- <sup>147</sup> Jakobson, "Aphasia as a Linguistic Topic", 1955, SW II, 229–38, p. 233.
- <sup>148</sup> In his 1974 Holenstein discusses a type of opposition studied by Jakobson of extreme importance in natural languages and other sign-systems: the opposition between marked and unmarked terms. Husserl and Stumpf had isolated the phenomenon of *Verschmelzung* (blending or fusion) as this pertains to the phenomenal continuity of perceptual or act moments. It seems that unmarkedness is a linguistic correlate of continuity for objects and acts. Cf. n. 104 above.
- <sup>149</sup> See especially G. Ungeheuer, 1959, but also A. Juilland and H.-H. Lieb, *Klasse und Klassifikation in der Sprachwissenschaft*, Haag: Mouton, 1968, p. 58 f, and J. W. F. Mulder, *Sets and Relations in Phonology. An Axiomatic Approach to the Description of Speech*, Oxford: Clarendon Press, 1968.
- <sup>150</sup> On implicational laws see also Jakobson, "Results of a Joint Conference of Anthropologists and Linguists", 1953, SW II, 554–67, p. 563 and also his 1963. Compare Holenstein 1974, p. 36 of Eng. trans., and § 4 of "Zur Begrifflichkeit der Universalienforschung in Linguistik und Anthropologie", *Arbeiten des Kölner Universalien-Projekts*, 35, 1979. On linguistic universals in general see J. H. Greenberg, ed., *Universals of Language*, Cambridge, Mass.: M.I.T. Press, 1963. See also text to nn. 15 and 86 above.
- <sup>151</sup> SW I, p. 320. Further examples are provided throughout Jakobson's works. See also Holenstein, 1976a and 1976b.

- <sup>152</sup> Jakobson's work on aphasia is complemented by the investigations of the consequences of brain damage by Gelb and Goldstein listed in the bibliography at the end of this volume.
- <sup>153</sup> SW I, p. 321.
- <sup>154</sup> See also the work of Hjelmslev on dependence, as presented e.g. in B. Siertma, *A Study of Glossematics*, Haag: Nijhoff, 1955 (here 'interdependence' = our 'reciprocal dependence', 'determination' = 'one-sided dependence', 'constellation' = 'mutual compatibility'). Literature on semantic features tends to be more recent, but see, on word-fields, J. Trier, "Das sprachliche Feld . . ." (n. 112 above).
- <sup>155</sup> See Holenstein, 1974.
- <sup>156</sup> In a more complete account it would be necessary to discuss also the work of R. A. Hudson, particularly his recent *Arguments for a Non-Transformational Grammar*, 1976. Whilst by no means falling under the influence of Husserl, Hudson has nevertheless contributed substantially to our understanding of the project of a Husserlian grammar. The work in question sets out a typology of the dependence relations to which different grammatical theories are committed. He points out that whereas European dependency grammars such as those of L. Tesnière, *Éléments de Syntaxe Structurale*, Paris: Klincksieck, 1959 and H.-J. Heringer, *Theorie der deutschen Syntax*, Munich: Hüber, 1970, have made use of bi- and multilateral dependence (horizontal or 'sisterhood') relations between parts, not only did the 'immediate constituent' analysis of American structuralism concentrate exclusively on whole-part (vertical or 'mother-daughter') relations in which larger syntactic units are seen as being quite literally composed of smaller ones, this one-sided emphasis on vertical relations was taken over by transformational grammar. Hudson's grammar, like the pure grammar outlined by Husserl, makes use of both sorts of relations and shows the importance of dependency relations both between parts i.e. categories (such as noun-phrase and verb) and between features (such as [+ transitive] and [+ nominal]).
- <sup>157</sup> The given properties and effects are, in the terminology of the philosophy of science, *emergent*: "A property *P* of a whole *w* is an *emergent wholistic property* (relative to the theory *T*, a decomposition *D* of *w* into parts, and a set *G* of properties) if '*P(w)*' cannot be deduced from the body of knowledge consisting of (1) the theory *T*, and (2) a characterization with regard to all the properties of *G* of the parts of *w* which are members of the decomposition *D*". This definition, given by Rescher in his reply to Madden, 1952 (*Philosophy of Science*, 20, 1953, p. 327) and adapted from the definition given by C. G. Hempel and P. Oppenheim in "Studies in the Logic of Explanation", *Philosophy of Science*, 15, 1948, 135-75, provides only an approximation to the concept of absolute emergence (as contrasted with emergence relative to a theory *T*) defended by Köhler (see e.g., op. cit., pp. 34, 169).
- <sup>158</sup> The first criterion, of 'Übersummativität', is formulated by Ehrenfels on pp. 13-16 of his 1890; the second criterion of 'Transponierbarkeit' on pp. 18-21. For literature on Ehrenfels' criteria see Gelb, 1911.
- <sup>159</sup> The notion of functional proximity or functional interdependence is very close to Husserl's notion of mutual foundation discussed above.
- <sup>160</sup> Other examples considered by Köhler include magnetic fields, membranes, osmotic systems, energy fields (e.g. high temperature systems giving rise to work, in the physical sense, and kinetic energy structures in hydrodynamics), and electric circuits. Köhler notes that the non-additive character of all of these examples had been recognised long before 'Gestalten' were discovered by Ehrenfels in 1890 (op. cit., p. 92, 124, *et passim*). The concept of *relative difference* has played an important role in more recent work in structuralist linguistics and elsewhere.
- <sup>161</sup> The idea that physical structures could throw light on psychological structures was rejected by the Ganzheits-psychologists (Krueger, Volkelt, Sander, *et al.*), a parallel

movement to the Gestalt school, taking as their starting point the absolute heterogeneity of the two types of holistic formations, (Cf. Köhler, p.x.) Whilst many of Köhler's, and the other Gestalt-psychologists', specific claims concerning the physical properties of stimulus fields were later refuted by independent physiological evidence – a fact which led to an almost total abandonment of the Gestaltist research-programme in mainstream psychology – Köhler's arguments for the importance of non-summativity, in both physics and psychology, retain their validity. Maddens's argument in his 1952 to the effect that all that is of scientific importance which can be expressed in Gestaltist language can be re-expressed in (atomistic) analytic terms, an argument which echoes Gustav Bergmann's early work on Gestalt theory, misses the point. It could equally be argued that all that is mathematically valuable in contemporary mathematics can be re-expressed in the language of *Principia Mathematica*. There is however no one who would defend the view that this re-expression would succeed in making more perspicuous the (referential) content of mathematical propositions.

<sup>162</sup> These definitions apply equally to continuous as to discrete sums.

<sup>163</sup> We use the term 'Gestalt structure', with Köhler, as synonymous with 'Übersummativität', i.e. as implying merely the satisfaction of Ehrenfels' first criterion. On the various possible definitions of 'Übersummativität' see § 6.3 below.

<sup>164</sup> By 'thing' we are to understand 'non-living bodies in a stable state ... i.e. the greater part of the inorganic world insofar as this normally falls under our attention' (loc. cit.).

<sup>165</sup> The moments of an *Eigenstruktur* are, further, non-extensive moments: they cannot be subjected to piecing in the way in which e.g. the colour-distribution across a surface can be pieced. Köhler was aware of Husserl's 3rd Logical Investigation and frequently employs the piece/moment opposition in his work, without however accepting Husserl's theory of foundation (see below).

The non-extensive character of *Eigenstrukturmomente* is illustrated by the example of current flowing through a liquid or through a non-homogeneous conductor (p. 137 f): "There are no partial currents to be encountered in particular regions of the conductor and which might therefore also be encountered in the absence of the remainder of the current; in our theoretical conceptions of the current in specific regions we have much rather to deal, as in the electrostatic case, with *moments* which *carry* the remaining current as well as being themselves supported by it; for as independent formations they are, in relation to the given physical form, not capable of existence."

Köhler discusses not only the concept of an *Eigenstruktur* but also the complementary concept of a *Feldstruktur* (field structure). The former is illustrated by the magnetic properties intrinsic to a magnetised body, the latter by the magnetic properties of the environment of the body. The field is, for Köhler, not a mathematical fiction (as in Faraday's electrostatic theory) but a *realer Zustand des Mediums* (p. 70). The properties of the field are univocally determined by the *Eigenstruktur* and thus also by the physical form of the underlying material. The two structures cannot however exist in isolation from each other: they are inseparable, equally real sides of a single formation (p. 71).

<sup>166</sup> The works acknowledged by Köhler himself as having contributed to the logic of non-summative wholes are Wertheimer, 1912 (particularly the remarks on the theory of categories); Stumpf, 1906a; and Krueger, *Über Entwicklungspsychologie, ihre sachliche und geschichtliche Notwendigkeit*, Leipzig: Engelmann, 1915, (see op. cit., p. 58n).

<sup>167</sup> See the second half of n. 78 above.

<sup>168</sup> The classic statement of the atomist position in 20th century philosophy is Wittgenstein's *Tractatus*. The concept of independence can be applied not merely to objects but also to states of affairs and to events. Again, Wittgenstein's *Tractatus* offers an extreme view as to the lack of interdependence of states of affairs, implying a position ac-

- ording to which "There is no special object peculiar to probability propositions" (5.1511). This position was criticised, along lines very similar to those defended by Köhler, in J. v. Kries, *Die Principien der Wahrscheinlichkeitsrechnung. Eine logische Untersuchung*, Freiburg: Mohr (Siebeck), 1886 and in Meinong's, 1915.
- <sup>169</sup> Similarly the fact that ordinary everyday experience exhibits mainly additive wholes has led many philosophers to overestimate the power of set theory as a basis for philosophical ontology.
- <sup>170</sup> See also Lewin, 1923. 'Wissenschaftslehre' in Lewin's work is to be understood in the sense of Stumpf, 1906a.
- <sup>171</sup> It is clear that no thing can be genidentical with an event (see vol. I of Ingarden, 1964/65). For the distinction between genidentity sequences of things and of events Lewin refers to Lotze, *Metaphysik*, Leipzig: Hirzel, 1880, p. 8.
- <sup>172</sup> ' $\vee$ ' may be defined in terms of ' $\leq$ ' as follows:  $a/b := \exists x (x \leq a \ \& \ x \leq b)$ .
- <sup>173</sup> Lewin designates '[ $a, b, \dots$ ]' as the 'mathematische Zusammenfassung' (i.e. the mereological sum) of discrete  $a, b, \dots$ .
- <sup>174</sup> Here numerical subscripts indicate successive generations.
- <sup>175</sup> One further species of genidentity is considered by Lewin (pp. 121–200), the relation of *Stammgenidentität* obtaining between temporally distinct sections through phylogenetic *Stämme* (a concept broad enough to include biological species, races, tribes, individual families, and in principle also nations). This concept is used by Lewin to throw light on the relation of consanguinity, on the problem of providing identity criteria for biological species, and in particular on the possibility of splitting and merging of *Stämme*.
- <sup>176</sup> Thus Rausch will consider only extensive wholes and their piece-wise partitions (op. cit., p. 213). He will however find it possible to find a place for certain non-extensive relations between properties of a whole: see the discussion of  $N^w$  below.
- <sup>177</sup> Whilst Rausch considers only finite partitions, the taxonomy he develops is in principle generalisable to the infinite case.
- <sup>178</sup> "The partition" writes Rausch, "relates primarily not to the substantial object, but to a specific spatial region. The object (the objectual manifold) is only secondarily subject to partition in that it occupies the given spatial region or is brought into it. It is however precisely this secondary partition which will be here of interest, since we are not concerned with purely geometrical problems, but rather with real existent things. Thus we impose the condition that every cell of the grid should contain at least some 'objectual substance' ..." (p. 214).
- <sup>179</sup> ' $(Z^E - t_i)$ ' designates simply the result of removing  $t_i$  from  $Z^E$ ; ' $t_i$ ', in what follows, shall serve as an abbreviation for ' $t_i(Z^E)$ '.
- <sup>180</sup> Still stronger versions of Köhler-summativity can be obtained by considering decompositions which involve the removal not only of single elements, but also of groups of elements. Variant concepts can be defined which take account of the *order* of removal. See Rausch, op. cit., pp. 231–34.
- <sup>181</sup> To all of the above concepts we can assign correlated concepts of non-summativity in a number of non-equivalent ways. We may, first of all, simply negate the formula on the right of the definition. Or we may substitute *variance* for *invariance* in this formula (yielding definitions which are once more negatable, giving rise to further concepts of summativity). See Rausch, pp. 239–41.
- <sup>182</sup> The relation of Rausch's discussion here to Husserl's concept of variation and to analytic philosophical work on variables and functions would merit an investigation of its own.
- <sup>183</sup> Two concepts of variation are at work here and in the formula which follows: the *formal* concept *var*, signifying (formal) variance under some operation or other, and the *material* concept,  $\psi$ , signifying some specific type of variation (e. g. a specific 2°C-increase in temperature). Cf. Rausch, op. cit., p. 274.

- <sup>184</sup> Many of the ideas in this section have their origins in work by our colleague Wolfgang Degen, of the University of Erlangen, particularly his "Skizze zur rationalen Grammatik" (MS, 96pp.) of 1979. Further details are provided in Smith, 1981 and in Smith and Mulligan, 1982.
- <sup>185</sup> For those who prefer realistic examples, we might remark that precisely parallel distinctions can be found e.g. in partnership law, and in the law of several property.
- <sup>186</sup> We should also hope that it might contribute to the rehabilitation of the term 'something' as a *bona fide* referring expression.
- <sup>187</sup> See also the first and third of the three papers by Simons below, as well as his paper "Logic and Common Nouns", *Analysis*, 38, 1978, 161–67.
- <sup>188</sup> Whilst, *qua* individual human beings, *a* and *b* are independent wholes, *qua* parties to a disagreement they are mutually dependent, a state of affairs which may be represented by:



- <sup>189</sup> Thus compare the diagram at the head of this section with that given on p. 119 of Black's *Companion to Wittgenstein's Tractatus*, Cambridge: Cambridge University Press, 1971.
- <sup>190</sup> There is an obvious connection also to chemical notation. An early attempt to develop a generalised theory of bonds, on the basis of chemical valency theory, was made by Clifford and Sylvester. See Clifford's paper "On an application of the new atomic theory to the graphical representation of the invariants and covariants of binary quantics", *American Journal of Mathematics*, 1, 1878, 64–125 and Sylvesters's note, "Chemistry and Algebra" on pp. 103–4 of his *Collected Mathematical Papers*, Cambridge: Cambridge University Press, 1909. The graph-theoretic properties of the diagrammatic forms considered in the present paper have been investigated by Wolfgang Degen.
- <sup>191</sup> This *principle of downward closure* does not, of course, imply that all constituents of existing states of affairs exist as independent wholes. Stronger principles of downward closure, which do have this implication, are characteristic of ontological atomism. A principle of intermediate strength would assert that only those constituents of states of affairs which are independent wholes (and which correspond to saturated sub-formulae of the corresponding propositional signs) can properly be said to exist. A formal system which accepts the principle of downward closure in any of these forms thereby renders itself incapable of formalising either negation or disjunction – a consequence of the fact that negative and disjunctive states of affairs do not exist (or do not exist in the same sense as positive states of affairs). Since, however, a directly depicting language is capable, as we have already seen, of simulating certain types of existential quantification, it follows that the orthodox interpretation of existential quantification as a form of multiple disjunction has to be rejected (a surely intuitively acceptable consequence of the fact that a statement such as 'there is an apple on the table' does not involve the type of running through of all the objects in the universe which is involved in a reading of '∃ x(x is on the table)' as 'x<sub>1</sub> is on the table ∨ x<sub>2</sub> is on the table ∨ x<sub>3</sub> is on the table ∨ ...').
- <sup>192</sup> For example of the type advanced by D. Davidson in his "The Logical Form of Action Sentences", in Rescher, ed., *The Logic of Decision and Action*, Pittsburgh: University of Pittsburgh Press, 1967, 81–95.
- <sup>193</sup> Strictly speaking a complete representation of 'Hans kisses Erna . . .' would have to take account of the fact that Hans here serves as agent, Erna as patient. Degen proposes to represent the *actio* and *passio* involved by distinguishing two kinds of inherence, for example by:

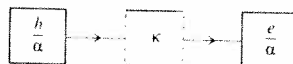

with additional symbols of this sort corresponding to further types of categorial relations among substances and accidents, for example, to the relations of causality or of temporal succession. An alternative solution would consist in distinguishing, within Hans and Erna themselves, constituent moments of agency and patiency, thereby obviating the need to move away from a system embodying the single, purely formal relation of inherence or one-sided foundation.

<sup>194</sup> Again, a complete formal representation of 'Hans kisses Erna' would have to take account of the differences between 'Hans kisses Erna a number of times', 'Hans kisses Erna as a matter of habit', etc.

<sup>195</sup> In some developments of the system such disjoint formulae would be disallowed, on the basis of an appeal to the fact that disconnected states of affairs do not exist (or do not exist in the same sense as connected states of affairs); *im Sachverhalt hängen die Gegenstände ineinander wie die Glieder einer Kette*.

<sup>196</sup> This rule corresponds to the acceptance of a *principle of upward closure*, and again, a number of distinct principles of upward closure, of varying strengths, might prove to be acceptable. Bradley, for example, would seem to be committed to the view that from any (abstractly demarcated) state of affairs we may infer the single all-embracing state of affairs which is the world as a whole.

<sup>197</sup> More precisely, we should have to say that, in contrast to the views of the scholastic philosophers (and of Husserl in the *Logical Investigations*), material essences do not constitute trees, but more complex structures, loosely identifiable as graph-theoretical products of trees). Work on these structures (or on the logic of common noun expressions) is however in its infancy (again, as a result of the dominance of set theory and of predicate logic amongst contemporary philosophers).

<sup>198</sup> There is no limit to the degree to which the constituent figures of a propositional sign may be nested inside each other (though clearly, if we are to preserve the directly depicting property of the language, we must insist that no figure be either mediately or immediately properly nested inside itself). The question arises as to whether we can accept the purely formal inference rule:

$$\frac{\Gamma}{\boxed{\Delta}},$$

where  $\Delta$  is a propositional formula including  $\Gamma$  as sub-formula. This rule would correspond to a principle ruling out the possibility of free accidents (or of free non-independent wholes in general), i. e. to the view that all accidents are constituents of larger, independent wholes.

<sup>199</sup> Thus for example the range of possible consequences of the pair  $\boxed{a}$ ,  $\boxed{b}$  of propositional signs includes as many as 9 distinct cases, a number which is increased by several orders of magnitude when 3, 4 or 5 propositional signs are taken as starting point.

<sup>200</sup> This presents no significant problems other than the combinatorial difficulties mentioned above. Cf. Smith and Mulligan, 1982.